

**SAMSUNG**

# VRF Technical Data Book

Wind-Free 4Way Cassette  
for North America  
(R410A, HP)



Model : AM\*\*\*NN4DCH/\*\*

# History

---

Version	Modification	Date	Remark
Ver.1.0	Released VRF Wind-Free 4Way Cassette for north America (60Hz)	18. 02. 21	
Ver.1.1	Updated the panel model name in specification page	19. 01. 22	



# Features & Benefits

## Innovative Features

### Wind-Free Cooling

Stay cool, but no cold draft by Micro Hole

Micro Holes

### Big Blade, Long Wind

Faster & Wider cooling by Big Blade

84mm Big Blade  
6.0m 2 Times Wider

### Smart Comfort Operation

Automatic Wind-Free Operation by temp. & humidity sensor

Temperature & Humidity Sensor  
Judgement  
Comfort Condition  
Wind-Free Cooling  
Normal Condition  
Normal Cooling

### New MDS Operation

Optimized operation & energy saving by MDS

- Direct / Indirect Wind
- Wind-Free & On/Off Control during absence

## Wind-Free Cooling with Micro holes

- The Wind Free Air conditioner pushes air out through more 10,000 micro holes in the panel, producing a dispersed and gentle flow of air actually defined as “still air” and the key here is all of those holes create a still, cooled air flow that infiltrates the room gently and softly.
- ※ Still Air condition : According to ASHRAE, If velocity of wind is lower than 0.15m/s, People can not detect wind. And they define that condition is “Still Air”

## No Direct Wind & Cold Draft



[ Comparison of Room Temperature ]

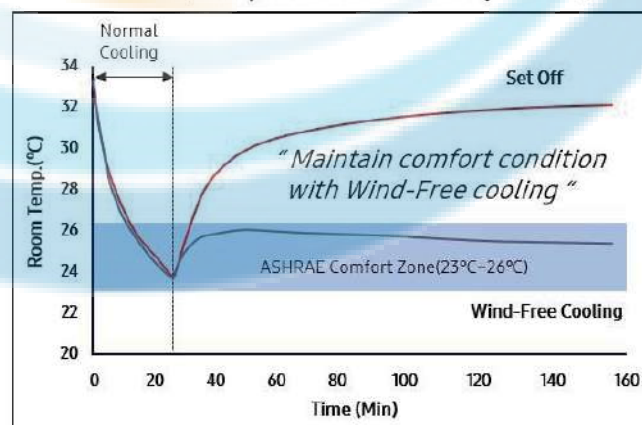

※ Internal Test (48kbtu Model @ 122m<sup>3</sup>)

# Nomenclature

## Indoor Unit

### Model Name

<b>AM</b>	<b>015</b>	<b>N</b>	<b>N</b>	<b>N</b>	<b>D</b>	<b>C</b>	<b>H</b>	/	<b>**</b>
(1)	(2)	(3)	(4)	(5)	(6)	(7)	(8)		Buyer

#### (1) Classification

<b>AM</b>	DVM
-----------	-----

#### (5) Product Notation

<b>N</b>	(Wind-Free) 4Way Cassette(600x600)
<b>4</b>	(Wind-Free) 4Way Cassette

#### (2) Capacity

X kBtu/h (3digits)
--------------------

#### (6) Feature

<b>P</b>	Premium
<b>D</b>	Deluxe

#### (3) Version

<b>K</b>	2016
<b>M</b>	2017
<b>N</b>	2018

#### (7) Rating Voltage

<b>C</b>	1Φ, 208~230V, 60Hz
----------	--------------------

#### (4) Product Type

<b>N</b>	Indoor Unit
<b>X</b>	Outdoor Unit

#### (8) Mode

<b>H</b>	Heat Pump (R410A)
----------	-------------------















# Line-up

---

## Indoor unit

---

Model	Capacity (kBtu/h)									
	5	7	9	12	18	20	24	30	36	48
Wind-Free 4Way CST (600x600)										
Wind-Free 4Way CST										

# Contents

---

Wind-Free 4Way Cassette (600x600)	7
Wind-Free 4Way Cassette	31
Installation	58
Accessory	65

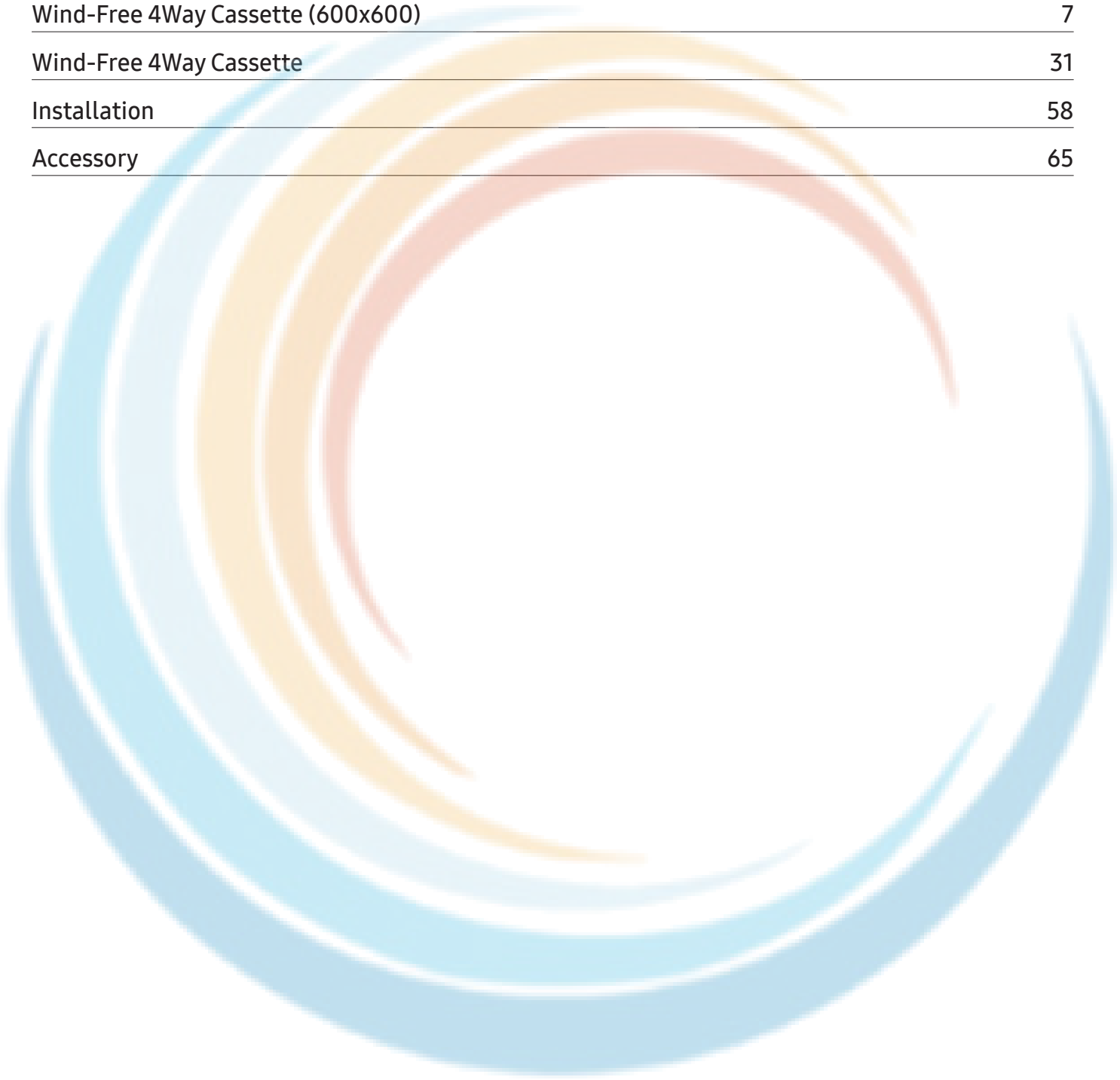

# 4Way Cassette (600x600)

---

1. Specification	9
2. Summary Table	13
3. Capacity Table	14
4. Dimensional Drawing	20
5. Center of Gravity	21
6. Electrical Wiring Diagram	22
7. Sound Data	23
8. Temperature and air flow distribution	27
9. Piping Diagram	30

# Features & Benefits

## Wind-Free 4Way Cassette (600x600)

### Add chic flair to your interior design with a stylish yet powerful AC system

Samsung's advanced Wind-Free 4Way Cassette (600 x 600) builds on the aesthetic appeal and performance of the standard Wind-Free 4Way Cassette with an enhanced design. The Wind-Free 4Way Cassette (600 x 600) comes in a variety of patterns to complement any interior. The stylish cassette unit visually harmonizes with the indoor space, while efficient cooling and heating performance make it a dependable and practical air conditioning solution.

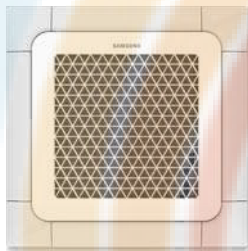

The Wind-Free 4Way Cassette (600 x 600) indoor air conditioning system provides high-performance heating and cooling in an elegant design with features such as:

- **Tasteful design and compact, lightweight build.** Create a polished ambiance with a discreetly sized design and a choice of attractive panel patterns.
- **Enhanced comfort control.** Optimize comfort and save energy with optional motion detection.
- **Low maintenance and powerful airflow.** Ease installation and maintenance and maximize airflow with an efficient design and robust performance.

## Wind-Free 4Way Cassette (600 x 600) - Tasteful design, Compact, Lightweight build

### Refine the interior with an elegant, compact design

The enhanced Samsung Wind-Free 4Way Cassette (600 x 600) indoor air conditioner features a selection of simple panel patterns to blend seamlessly into any interior design. Its uniquely lightweight frame blends effortlessly and beautifully into any décor, while clever blade construction keeps the unit clean for a tidy appearance.

### Attractive panel and display

The Wind-Free 4Way Cassette (600 x 600) features a fashionable panel with a simple, beveled corner design. The rounded panel frame promotes a neat, tidy look for an aesthetic flair that blends perfectly with any ambience.



### Ultra-compact size

Samsung's Wind-Free 4Way Cassette (600 x 600) air conditioner can be installed on a single standard ceiling tile (600W x 600D) which helps minimize installation time and effort.



### Light, robust design

The Samsung Wind-Free 4Way Cassette (600 x 600) indoor unit is now lighter in weight at 12kg. It is the lightest indoor unit in the industry, about 30 percent lighter than our conventional products.

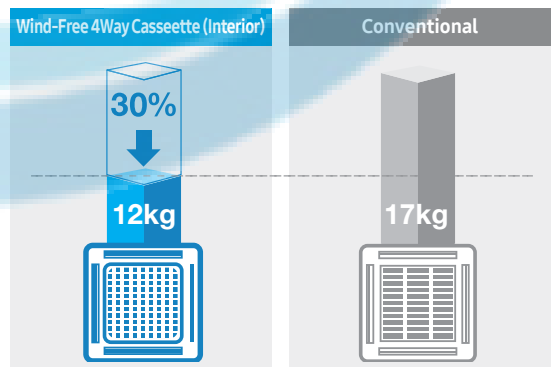

\*Based on 3.6kW



# 1. Specification

## Wind-Free 4Way Cassette (600x600)

Type			4Way CASSETTE (600x600)	4Way CASSETTE (600x600)	4Way CASSETTE (600x600)		
Model Name			AM005NNNDCH/AA	AM007NNNDCH/AA	AM009NNNDCH/AA		
Power Supply		Φ, #, V, Hz	1,2,208-230,60	1,2,208-230,60	1,2,208-230,60		
Mode			-	HP/HR	HP/HR		
Performance	TON	Capacity	Ton	0.42	0.63	0.79	
			Cooling	kW	1.47	2.20	2.78
				Btu/h	5,000	7,500	9,500
		US RT		0.42	0.63	0.79	
		Heating	kW	1.76	2.55	3.08	
			Btu/h	6,000	8,700	10,500	
US RT	0.50		0.73	0.88			
Power	Power Input	Cooling	W	18.00	18.00	24.00	
		Heating		18.00	18.00	24.00	
	Current Input	Cooling	A	0.17	0.17	0.17	
		Heating		0.17	0.17	0.17	
	Current	MCA	A	0.24	0.24	0.24	
		MOP		15	15	15	
Heat exchanger	Type		-	Fin & tube	Fin & tube	Fin & tube	
	Material	Fin	-	Al	Al	Al	
		Tube	-	Cu	Cu	Cu	
	Fin Treatment		-	Louver, Hydrophile	Louver, Hydrophile	Louver, Hydrophile	
Fan	Type		-	Turbo Fan	Turbo Fan	Turbo Fan	
	Quantity		EA	1	2	3	
	Air Flow Rate	H/M/L	m <sup>3</sup> /min		8.50/7.20/6.50	9.00/7.70/6.50	10.00/8.50/7.50
			ft <sup>3</sup> /min		300/254/230	318/272/230	353/300/265
			l/s		142/120/108	150/128/108	167/142/125
	External Pressure	Max. (Min/Std/Max)	mmAq		-	-	-
Pa				-	-	-	
In Wg				-	-	-	
Fan Motor	Type		-	BLDC	BLDC	BLDC	
	Output x n		W	65 x 1	65 x 1	65 x 1	
Piping Connections	Liquid Pipe	Type		Flare connection	Flare connection	Flare connection	
		Φ, mm (inch)		6.35 (1/4)	6.35 (1/4)	6.35 (1/4)	
	Gas Pipe	Type		Flare connection	Flare connection	Flare connection	
		Φ, mm (inch)		12.70 (1/2)	12.70 (1/2)	12.70 (1/2)	
Heat insulation		-					
Drain Pipe		Φ,mm	VP25 (OD 32,ID 25)	VP25 (OD 32,ID 25)	VP25 (OD 32,ID 25)		
Wiring connections	Communication	Min.	mm <sup>2</sup>	2 X 16 AWG SHIELDED	2 X 16 AWG SHIELDED	2 X 16 AWG SHIELDED	
		Remark		-			
Refrigerant	Type		-	R410A	R410A	R410A	
	Electronic Expansion Valve		-	EEV INCLUDED	EEV INCLUDED	EEV INCLUDED	
Sound	Sound Pressure Level	H/M/L	dB(A)	30/28/23	32/29/25	33/30/26	
	Sound Power	Cooling		46	47	50	
External Dimension	Net Weight		kg (lbs)	11.7	12	12	
	Shipping Weight		kg (lbs)	13.7	14	14	
	Net Dimensions (WxHxD)	mm		575 x 250 x 575	575 x 250 x 575	575 x 250 x 575	
		inch		22 5/8 x 9 13/16 x 22 5/8	22 5/8 x 9 13/16 x 22 5/8	22 5/8 x 9 13/16 x 22 5/8	
	Shipping Dimensions (WxHxD)	mm		623 x 298 x 653	623 x 298 x 653	623 x 298 x 653	
inch		24 5/16 x 11 5/16 x 24 5/16	24 5/16 x 11 5/16 x 24 5/16	24 5/16 x 11 5/16 x 24 5/16			
Casing	Material			HIPS	HIPS	HIPS	

# 1. Specification

## Wind-Free 4Way Cassette (600x600)

Type			4Way CASSETTE (600x600)	4Way CASSETTE (600x600)	4Way CASSETTE (600x600)	
Model Name			AM005NNNDCH/AA	AM007NNNDCH/AA	AM009NNNDCH/AA	
Panel	Model Name	-	PC4SUFMAN PC4SUFMUN	PC4SUFMAN PC4SUFMUN	PC4SUFMAN PC4SUFMUN	
	Type	-	Wind Free Type	Wind Free Type	Wind Free Type	
	Material	-	HIPS	HIPS	HIPS	
	Color	-	White	White	White	
	Net Weight	kg (lbs)	2.7	2.7	2.7	
	Shipping Weight	kg (lbs)	3.9	3.9	3.9	
	Net Dimensions (W×H×D)	mm		620 x 57 x 620	620 x 57 x 620	620 x 57 x 620
		inch		24 5/16 x 2 1/4 x 24 5/16	24 5/16 x 2 1/4 x 24 5/16	24 5/16 x 2 1/4 x 24 5/16
Shipping Dimensions (W×H×D)	mm		670 x 120 x 655	670 x 120 x 655	670 x 120 x 655	
	inch		27 5/16 x 4 5/16 x 27 5/16	27 5/16 x 4 5/16 x 27 5/16	27 5/16 x 4 5/16 x 27 5/16	
Drain Pump	Drain Pump	-	included	included	included	
	Max. lifting Height / Displacement	in / gal/h	29-5/16 6.34gal/h	29-5/16 6.34gal/h	29-5/16 6.34gal/h	
Additional Accessories	Drain Pump	External Model	-	-	-	
		Internal Model	-	-	-	
		Max. lifting Height / Displacement	in / gal/h	-	-	-
	Air Filter	-	-	-	-	

### NOTE

- Specification may be subject to change without prior notice.
  - 1) Mode : HP(Heat Pump), HR(Heat Recovery)
  - 2) Performances are based on the following test conditions.
    - Cooling : Indoor temperature : 80°F(26.7°C) DB, 67°F(19.4°C) WB, Outdoor temperature : 95°F(35°C) DB, 75°F(23.9°C) WB
    - Heating : Indoor temperature : 70°F(21.1°C) DB, 60°F(15.6°C) WB, Outdoor temperature : 47°F(8.3°C) DB, 43°F(6.1°C) WB
    - Equivalent refrigerant pipe length 25ft(7.5m), Level differences 0ft(0m)
  - 3) Sound pressure level is obtained in an anechoic room.
    - Sound pressure level is a relative value, depending on the distance and acoustic environment.
    - Sound pressure level may differ depending on operation condition.
    - dBA = A-weighted sound pressure level
    - Reference acoustic pressure 0 dB = 20uPa
  - 4) Sound power level is an absolute value that a sound source generates.
    - dBA = A-weighted sound power level
    - Reference power : 1pW
    - Measured according to ISO 3741
  - 5) These products contain R410A which is fluorinated greenhouse gas.
  - 6) Select wire size based on the value of MCA

# 1. Specification

## Wind-Free 4Way Cassette (600x600)

Type			4Way CASSETTE (600x600)	4Way CASSETTE (600x600)	4Way CASSETTE (600x600)	
Model Name			AM012NNNDCH/AA	AM018NNNDCH/AA	AM020NNNDCH/AA	
Power Supply		Φ, #, V, Hz	1,2,208-230,60	1,2,208-230,60	1,2,208-230,60	
Mode			-	HP/HR	HP/HR	
Performance	TON	Cooling	Ton	1.00	1.5	1.67
			kW	3.52	5.28	5.86
			Btu/h	12,000	18,000	20,000
		Heating	US RT	1.00	1.5	1.67
			kW	3.96	5.86	6.74
			Btu/h	13,500	20,000	23,000
Power Input		W	28.00	36.00	38.00	
Power	Current Input	Cooling	0.19	0.27	0.30	
		Heating	0.19	0.27	0.30	
	Current	MCA	0.26	0.38	0.41	
		MOP	15	15	15	
Heat exchanger	Type	-	Fin & tube	Fin & tube	Fin & tube	
	Material	Fin	-	Al	Al	
		Tube	-	Cu	Cu	
	Fin Treatment	-	Louver, Hydrophile	Louver, Hydrophile	Louver, Hydrophile	
Fan	Type	-	Turbo Fan	Turbo Fan	Turbo Fan	
	Quantity	EA	4	5	6	
	Air Flow Rate	H/M/L	m <sup>3</sup> /min	10.50/9.50/8.00	13.00/11.00/9.50	13.50/12.00/10.20
			ft <sup>3</sup> /min	371/335/283	459/388/335	477/424/360
			l/s	175/158/133	217/183/158	225/200/170
	External Pressure	Max. (Min/Std/Max)	mmAq	-	-	-
Pa			-	-	-	
In Wg			-	-	-	
Fan Motor	Type	-	BLDC	BLDC	BLDC	
	Output x n	W	65 x 1	65 x 1	65 x 1	
Piping Connections	Liquid Pipe	Type	Flare connection	Flare connection	Flare connection	
		Φ, mm (inch)	6.35 (1/4)	6.35 (1/4)	6.35 (1/4)	
	Gas Pipe	Type	Flare connection	Flare connection	Flare connection	
		Φ, mm (inch)	12.70 (1/2)	12.70 (1/2)	12.70 (1/2)	
Heat insulation	-					
Drain Pipe	Φ,mm	VP25 (OD 32,ID 25)	VP25 (OD 32,ID 25)	VP25 (OD 32,ID 25)		
Wiring connections	Communication	Min.	mm <sup>2</sup>	2 X 16 AWG SHIELDED	2 X 16 AWG SHIELDED	
		Remark	-			
Refrigerant	Type	-	R410A	R410A	R410A	
	Electronic Expansion Valve	-	EEV INCLUDED	EEV INCLUDED	EEV INCLUDED	
Sound	Sound Pressure Level	H/M/L	dB(A)	34/30/26	39/36/33	
	Sound Power	Cooling		51	56	
External Dimension	Net Weight		kg (lbs)	12	12	
	Shipping Weight		kg (lbs)	14	14	
	Net Dimensions (WxHxD)	mm		575 x 250 x 575	575 x 250 x 575	575 x 250 x 575
		inch		22 5/8 x 9 13/16 x 22 5/8	22 5/8 x 9 13/16 x 22 5/8	22 5/8 x 9 13/16 x 22 5/8
	Shipping Dimensions (WxHxD)	mm		623 x 298 x 653	623 x 298 x 653	623 x 298 x 653
inch		24 5/16 x 11 5/16 x 24 5/16	24 5/16 x 11 5/16 x 24 5/16	24 5/16 x 11 5/16 x 24 5/16		
Casing	Material		-	HIPS	HIPS	

# 1. Specification

## Wind-Free 4Way Cassette (600x600)

Type			4Way CASSETTE (600x600)	4Way CASSETTE (600x600)	4Way CASSETTE (600x600)	
Model Name			AM012NNNDCH/AA	AM018NNNDCH/AA	AM020NNNDCH/AA	
Panel	Model Name	-	PC4SUFMAN PC4SUFMUN	PC4SUFMAN PC4SUFMUN	PC4SUFMAN PC4SUFMUN	
	Type	-	Wind Free Type	Wind Free Type	Wind Free Type	
	Material	-	HIPS	HIPS	HIPS	
	Color	-	White	White	White	
	Net Weight	kg (lbs)	2.7	2.7	2.7	
	Shipping Weight	kg (lbs)	3.9	3.9	0	
	Net Dimensions (W×H×D)	mm		620 x 57 x 620	620 x 57 x 620	620 x 57 x 620
		inch		24 5/16 x 2 1/4 x 24 5/16	24 5/16 x 2 1/4 x 24 5/16	24 5/16 x 2 1/4 x 24 5/16
Shipping Dimensions (W×H×D)	mm		670 x 120 x 655	670 x 120 x 655	670 x 120 x 655	
	inch		27 5/16 x 4 5/16 x 27 5/16	27 5/16 x 4 5/16 x 27 5/16	27 5/16 x 4 5/16 x 27 5/16	
Drain Pump	Drain Pump	-	included	included	included	
	Max. lifting Height / Displacement	in / gal/h	29-5/16 6.34gal/h	29-5/16 6.34gal/h	29-5/16 6.34gal/h	
Additional Accessories	Drain Pump	External Model	-	-	-	
		Internal Model	-	-	-	
		Max. lifting Height / Displacement	in / gal/h	-	-	-
	Air Filter	-	-	-	-	

### NOTE

- Specification may be subject to change without prior notice.
  - 1) Mode : HP(Heat Pump), HR(Heat Recovery)
  - 2) Performances are based on the following test conditions.
    - Cooling : Indoor temperature : 80°F(26.7°C) DB, 67°F(19.4°C) WB, Outdoor temperature : 95°F(35°C) DB, 75°F(23.9°C) WB
    - Heating : Indoor temperature : 70°F(21.1°C) DB, 60°F(15.6°C) WB, Outdoor temperature : 47°F(8.3°C) DB, 43°F(6.1°C) WB
    - Equivalent refrigerant pipe length 25ft(7.5m), Level differences 0ft(0m)
  - 3) Sound pressure level is obtained in an anechoic room.
    - Sound pressure level is a relative value, depending on the distance and acoustic environment.
    - Sound pressure level may differ depending on operation condition.
    - dBA = A-weighted sound pressure level
    - Reference acoustic pressure 0 dB = 20uPa
  - 4) Sound power level is an absolute value that a sound source generates.
    - dBA = A-weighted sound power level
    - Reference power : 1pW
    - Measured according to ISO 3741
  - 5) These products contain R410A which is fluorinated greenhouse gas.
  - 6) Select wire size based on the value of MCA



## 2. Summary Table

### Wind-Free 4Way Cassette (600x600)

#### Performance Characteristics

Model Code	Net Weight (lbs)	Fan Speed	Capacity			Airflow (CFM)	Sound Pressure (dBA)	Sound Power (dBA)
			Cooling (Btu/h)	Sensible (Btu/h)	Heating (Btu/h)			
AM005NNNDCH/AA	25.8	High	5000	3300	6000	300.2	30	46
		Mid	3200	2500	5500	254.3	28	
		Low	2400	2000	5200	229.6	23	
AM007NNNDCH/AA	26.5	High	7500	5100	8700	317.9	32	47
		Mid	4800	3800	8000	272.0	29	
		Low	3500	3000	7400	229.6	25	
AM009NNNDCH/AA	26.5	High	9500	6700	10500	353.2	33	50
		Mid	6100	5000	9700	300.2	30	
		Low	4500	4000	9100	264.9	26	
AM012NNNDCH/AA	26.5	High	12000	8300	13500	370.9	34	51
		Mid	8000	6400	12800	335.5	30	
		Low	5800	5000	11800	282.6	26	
AM018NNNDCH/AA	26.5	High	18000	12400	20000	459.2	39	56
		Mid	11600	9200	18400	388.5	36	
		Low	8500	7400	17100	335.5	33	
AM020NNNDCH/AA	26.5	High	20000	15000	23000	476.8	40	57
		Mid	13200	11200	21700	423.8	38	
		Low	9600	8600	20000	360.3	35	

#### NOTE

- Sound data is based on cooling operation.

#### Electric Characteristics

Indoor Unit	Power Supply (Ø, #, V, Hz)	Power Input (W)	Current Input (A)	MCA (A)	MFA (A)	FLA (A)
AM005NNNDCH/AA	1,2,208~230,60	18	0.17	0.41	15	0.33
AM007NNNDCH/AA	1,2,208~230,60	18	0.17	0.41	15	0.33
AM009NNNDCH/AA	1,2,208~230,60	24	0.17	0.41	15	0.33
AM012NNNDCH/AA	1,2,208~230,60	28	0.19	0.41	15	0.33
AM018NNNDCH/AA	1,2,208~230,60	36	0.27	0.41	15	0.33
AM020NNNDCH/AA	1,2,208~230,60	38	0.3	0.41	15	0.33

#### NOTE

- MCA : Minimum circuit amperes
- MFA : Maximum fuse amperes
- FLA : Full load amperes
- Select wire size based on the value of MCA

# 3. Capacity Table

## Wind-Free 4Way Cassette (600x600)

Cooling

TC : Total Capacity, SHC : Sensible Heat Capacity

Capacity Index (MBH)	Outdoor Air Temp. (°F, WB)	Indoor temperature (°F, WB)													
		57		61		64		67		70		72		75	
		TC	SHC	TC	SHC	TC	SHC	TC	SHC	TC	SHC	TC	SHC	TC	SHC
		Btu/h	Btu/h	Btu/h	Btu/h	Btu/h	Btu/h	Btu/h	Btu/h	Btu/h	Btu/h	Btu/h	Btu/h	Btu/h	Btu/h
005	50	3,400	2,900	4,100	3,100	4,800	3,400	5,000	3,400	5,600	3,500	5,800	3,400	5,900	3,200
	54	3,400	2,900	4,100	3,100	4,800	3,400	5,000	3,400	5,600	3,500	5,800	3,400	5,900	3,200
	58	3,400	2,900	4,100	3,100	4,800	3,400	5,000	3,400	5,500	3,500	5,700	3,400	5,900	3,200
	60	3,400	2,900	4,100	3,100	4,800	3,400	5,000	3,400	5,400	3,400	5,700	3,300	5,900	3,200
	64	3,400	2,900	4,100	3,100	4,800	3,400	5,000	3,400	5,400	3,400	5,600	3,300	5,900	3,200
	67	3,400	2,900	4,100	3,100	4,800	3,400	5,000	3,400	5,400	3,400	5,600	3,300	5,900	3,200
	70	3,400	2,900	4,100	3,100	4,800	3,400	5,000	3,400	5,400	3,400	5,600	3,300	5,900	3,200
	73	3,400	2,900	4,100	3,100	4,800	3,400	5,000	3,400	5,400	3,400	5,600	3,300	5,900	3,200
	77	3,400	2,900	4,100	3,100	4,800	3,400	5,000	3,400	5,400	3,400	5,600	3,300	5,900	3,200
	80	3,400	2,900	4,100	3,100	4,800	3,400	5,000	3,400	5,400	3,400	5,600	3,300	5,900	3,200
	84	3,400	2,900	4,100	3,100	4,800	3,400	5,000	3,400	5,400	3,400	5,600	3,300	5,900	3,200
	88	3,400	2,900	4,100	3,100	4,800	3,400	5,000	3,400	5,400	3,400	5,600	3,300	5,900	3,200
	92	3,400	2,900	4,100	3,100	4,800	3,400	5,000	3,400	5,400	3,400	5,600	3,300	5,900	3,200
	95	3,400	2,900	4,100	3,100	4,800	3,400	5,000	3,400	5,400	3,400	5,600	3,300	5,900	3,200
	99	3,400	2,900	4,100	3,100	4,800	3,400	5,000	3,400	5,400	3,400	5,600	3,300	5,800	3,100
	103	3,400	2,900	4,100	3,100	4,800	3,300	4,900	3,300	5,400	3,300	5,500	3,200	5,700	3,000
107	3,400	2,900	4,100	3,100	4,800	3,300	4,900	3,300	5,300	3,300	5,500	3,200	5,600	2,900	
111	3,400	2,900	4,100	3,100	4,600	3,200	4,700	3,200	5,100	3,200	5,200	3,000	5,400	2,800	
115	3,400	2,900	4,000	3,100	4,600	3,200	4,600	3,100	5,000	3,100	5,100	2,900	5,200	2,700	
118	3,400	2,900	4,000	3,000	4,500	3,100	4,500	3,100	4,800	3,000	4,900	2,900	5,000	2,600	
007	50	5,100	4,400	6,200	4,800	7,200	5,200	7,500	5,200	8,300	5,200	8,700	5,200	9,100	5,100
	54	5,100	4,400	6,200	4,800	7,200	5,200	7,500	5,200	8,300	5,200	8,600	5,100	8,900	4,900
	58	5,100	4,400	6,200	4,800	7,200	5,200	7,500	5,200	8,300	5,200	8,600	5,100	8,900	4,900
	60	5,100	4,400	6,200	4,800	7,200	5,200	7,500	5,200	8,300	5,200	8,600	5,100	8,900	4,900
	64	5,100	4,400	6,200	4,800	7,200	5,200	7,500	5,200	8,200	5,200	8,600	5,100	8,900	4,900
	67	5,100	4,400	6,200	4,800	7,200	5,200	7,500	5,200	8,200	5,200	8,600	5,100	8,900	4,900
	70	5,100	4,400	6,200	4,800	7,200	5,200	7,500	5,200	8,200	5,200	8,600	5,100	8,900	4,900
	73	5,100	4,400	6,200	4,800	7,200	5,200	7,500	5,200	8,200	5,200	8,600	5,100	8,900	4,900
	77	5,100	4,400	6,200	4,800	7,200	5,200	7,500	5,200	8,200	5,200	8,600	5,100	8,900	4,900
	80	5,100	4,400	6,200	4,800	7,200	5,200	7,500	5,200	8,200	5,200	8,600	5,100	8,900	4,900
	84	5,100	4,400	6,200	4,800	7,200	5,200	7,500	5,200	8,200	5,200	8,600	5,100	8,900	4,900
	88	5,100	4,400	6,200	4,800	7,200	5,200	7,500	5,200	8,200	5,200	8,600	5,100	8,900	4,900
	92	5,100	4,400	6,200	4,800	7,200	5,200	7,500	5,200	8,200	5,200	8,600	5,100	8,900	4,900
	95	5,100	4,400	6,200	4,800	7,200	5,200	7,500	5,200	8,200	5,200	8,600	5,100	8,900	4,900
	99	5,100	4,400	6,200	4,800	7,200	5,200	7,500	5,200	8,200	5,100	8,500	5,000	8,900	4,900
	103	5,100	4,400	6,200	4,800	7,100	5,100	7,400	5,100	8,100	5,000	8,300	4,800	8,600	4,600
107	5,100	4,400	6,200	4,800	7,100	5,100	7,400	5,100	8,000	4,900	8,200	4,700	8,400	4,500	
111	5,100	4,400	6,200	4,800	6,900	5,000	7,100	4,900	7,700	4,800	7,900	4,600	8,100	4,400	
115	5,100	4,400	6,100	4,800	6,800	4,900	6,900	4,800	7,400	4,600	7,600	4,400	7,900	4,200	
118	5,100	4,300	6,000	4,700	6,700	4,800	6,800	4,700	7,300	4,500	7,400	4,300	7,600	4,100	

# 3. Capacity Table

## Wind-Free 4Way Cassette (600x600)

Capacity Index (MBH)	Outdoor Air Temp. (°F, WB)	Indoor temperature (°F, WB)													
		57		61		64		67		70		72		75	
		TC	SHC	TC	SHC	TC	SHC	TC	SHC	TC	SHC	TC	SHC	TC	SHC
		Btu/h	Btu/h	Btu/h	Btu/h	Btu/h	Btu/h	Btu/h	Btu/h	Btu/h	Btu/h	Btu/h	Btu/h	Btu/h	Btu/h
009	50	6,400	5,800	7,800	6,100	8,800	6,800	9,500	6,800	9,800	6,800	10,500	6,800	11,500	6,400
	54	6,400	6,800	7,800	7,100	8,800	6,800	9,500	6,800	9,800	6,800	10,500	6,800	11,200	6,100
	58	6,400	6,800	7,800	7,100	8,800	6,800	9,500	6,800	9,800	6,800	10,500	6,800	11,200	6,100
	60	6,400	6,800	7,800	7,100	8,800	6,800	9,500	6,800	9,800	6,800	10,500	6,800	11,200	6,100
	64	6,400	6,800	7,800	7,100	8,800	6,800	9,500	6,800	9,800	6,800	10,500	6,800	11,200	6,100
	67	6,400	6,800	7,800	7,100	8,800	6,800	9,500	6,800	9,800	6,800	10,500	6,800	11,200	6,100
	70	6,400	6,800	7,800	7,100	8,800	6,800	9,500	6,800	9,800	6,800	10,500	6,800	11,200	6,100
	73	6,400	6,800	7,800	7,100	8,800	6,800	9,500	6,800	9,800	6,800	10,500	6,800	11,200	6,100
	77	6,400	6,800	7,800	7,100	8,800	6,800	9,500	6,800	9,800	6,800	10,500	6,800	11,200	6,100
	80	6,400	6,800	7,800	7,100	8,800	6,800	9,500	6,800	9,800	6,800	10,500	6,800	11,200	6,100
	84	6,400	6,800	7,800	7,100	8,800	6,800	9,500	6,800	9,800	6,800	10,500	6,800	11,200	6,100
	88	6,400	6,800	7,800	7,100	8,800	6,800	9,500	6,800	9,800	6,800	10,500	6,800	11,200	6,100
	92	6,400	6,800	7,800	7,100	8,800	6,800	9,500	6,800	9,800	6,800	10,500	6,800	11,200	6,100
	95	6,400	6,800	7,800	7,100	8,800	6,800	9,500	6,800	9,800	6,800	10,500	6,800	11,200	6,100
	99	6,400	6,800	7,800	7,100	8,800	6,800	9,500	6,800	9,800	6,800	10,500	6,800	11,200	6,100
103	6,400	6,800	7,800	7,100	8,800	6,800	9,500	6,800	9,800	6,400	10,200	6,400	10,900	6,100	
107	6,400	6,800	7,800	7,100	8,800	6,800	9,200	6,400	9,500	6,400	9,800	6,100	10,200	5,800	
111	6,400	6,800	7,800	7,100	8,500	6,400	9,200	6,400	9,200	6,100	9,200	5,800	9,500	5,400	
115	6,400	6,800	7,800	7,100	8,500	6,400	9,200	6,400	9,200	6,100	9,200	5,800	9,500	5,400	
118	6,400	6,800	7,800	7,100	8,500	6,400	9,200	6,400	9,200	6,100	9,200	5,800	9,500	5,400	
012	50	8,300	7,300	9,700	8,300	11,300	9,000	12,000	9,300	12,300	9,300	13,300	9,300	14,300	9,000
	54	8,300	7,300	9,700	8,300	11,300	9,000	12,000	9,300	12,300	9,300	13,300	9,300	14,300	9,000
	58	8,300	7,300	9,700	8,300	11,300	9,000	12,000	9,300	12,300	9,300	13,300	9,300	14,300	9,000
	60	8,300	7,300	9,700	8,300	11,300	9,000	12,000	9,300	12,300	9,300	13,300	9,300	14,300	9,000
	64	8,300	7,300	9,700	8,300	11,300	9,000	12,000	9,300	12,300	9,300	13,300	9,300	14,300	9,000
	67	8,300	7,300	9,700	8,300	11,300	9,000	12,000	9,300	12,300	9,300	13,300	9,300	14,000	8,700
	70	8,300	7,300	9,700	8,300	11,300	9,000	12,000	9,300	12,300	9,300	13,300	9,300	14,000	8,700
	73	8,300	7,300	9,700	8,300	11,300	9,000	12,000	9,300	12,300	9,300	13,300	9,300	14,000	8,700
	77	8,300	7,300	9,700	8,300	11,300	9,000	12,000	9,300	12,300	9,300	13,300	9,300	14,000	8,700
	80	8,300	7,300	9,700	8,300	11,300	9,000	12,000	9,300	12,300	9,300	13,300	9,300	14,000	8,700
	84	8,300	7,300	9,700	8,300	11,300	9,000	12,000	9,300	12,300	9,300	13,300	9,300	14,000	8,700
	88	8,300	7,300	9,700	8,300	11,300	9,000	12,000	9,300	12,300	9,300	13,300	9,300	14,000	8,700
	92	8,300	7,300	9,700	8,300	11,300	9,000	12,000	9,300	12,300	9,300	13,300	9,300	14,000	8,700
	95	8,300	7,300	9,700	8,300	11,300	9,000	12,000	9,300	12,300	9,300	13,300	9,300	14,000	8,700
	99	8,300	7,300	9,700	8,300	11,300	9,000	12,000	9,300	12,300	9,300	13,000	9,000	14,000	8,700
103	8,300	7,300	9,700	8,300	11,300	9,000	12,000	9,300	12,300	9,300	13,000	9,000	13,700	8,300	
107	8,300	7,300	9,700	8,300	11,300	9,000	11,700	9,000	12,000	8,700	12,300	8,700	13,000	8,000	
111	8,300	7,300	9,700	8,300	10,700	8,700	11,300	8,700	11,700	8,300	11,700	8,300	12,000	7,700	
115	8,300	7,300	9,700	8,300	10,700	8,700	11,300	8,700	11,700	8,300	11,700	8,300	12,000	7,700	
118	8,300	7,300	9,700	8,300	10,700	8,700	11,300	8,700	11,700	8,300	11,700	8,300	12,000	7,700	

# 3. Capacity Table

## Wind-Free 4Way Cassette (600x600)

Capacity Index (MBH)	Outdoor Air Temp. (°F, WB)	Indoor temperature (°F, WB)													
		57		61		64		67		70		72		75	
		TC	SHC	TC	SHC	TC	SHC	TC	SHC	TC	SHC	TC	SHC	TC	SHC
		Btu/h	Btu/h	Btu/h	Btu/h	Btu/h	Btu/h	Btu/h	Btu/h	Btu/h	Btu/h	Btu/h	Btu/h	Btu/h	Btu/h
018	50	12,400	11,200	14,800	12,800	16,800	13,200	18,000	13,600	18,800	13,600	20,000	13,600	21,600	14,000
	54	12,400	11,200	14,800	12,800	16,800	13,200	18,000	13,600	18,800	13,600	20,000	13,600	21,600	14,000
	58	12,400	11,200	14,800	12,800	16,800	13,200	18,000	13,600	18,800	13,600	20,000	13,600	21,600	14,000
	60	12,400	11,200	14,800	12,800	16,800	13,200	18,000	13,600	18,800	13,600	20,000	13,600	21,200	12,800
	64	12,400	11,200	14,800	12,800	16,800	13,200	18,000	13,600	18,800	13,600	20,000	13,600	21,200	12,800
	67	12,400	11,200	14,800	12,800	16,800	13,200	18,000	13,600	18,800	13,600	20,000	13,600	21,200	12,800
	70	12,400	11,200	14,800	12,800	16,800	13,200	18,000	13,600	18,800	13,600	20,000	13,600	21,200	12,800
	73	12,400	11,200	14,800	12,800	16,800	13,200	18,000	13,600	18,800	13,600	20,000	13,600	21,200	12,800
	77	12,400	11,200	14,800	12,800	16,800	13,200	18,000	13,600	18,800	13,600	20,000	13,600	21,200	12,800
	80	12,400	11,200	14,800	12,800	16,800	13,200	18,000	13,600	18,800	13,600	20,000	13,600	21,200	12,800
	84	12,400	11,200	14,800	12,800	16,800	13,200	18,000	13,600	18,800	13,600	20,000	13,600	21,200	12,800
	88	12,400	11,200	14,800	12,800	16,800	13,200	18,000	13,600	18,800	13,600	20,000	13,600	21,200	12,800
	92	12,400	11,200	14,800	12,800	16,800	13,200	18,000	13,600	18,800	13,600	20,000	13,600	21,200	12,800
	95	12,400	11,200	14,800	12,800	16,800	13,200	18,000	13,600	18,800	13,600	20,000	13,600	21,200	12,800
	99	12,400	11,200	14,800	12,800	16,800	13,200	18,000	13,600	18,400	13,200	19,600	13,200	20,800	12,800
	103	12,400	11,200	14,800	12,800	16,800	13,200	18,000	13,600	18,400	13,200	19,600	13,200	20,400	12,400
107	12,400	11,200	14,800	12,800	16,800	13,200	17,600	13,200	18,000	12,800	18,400	12,400	19,200	12,800	
111	12,400	11,200	14,800	12,800	16,000	12,800	17,200	12,800	17,200	12,400	17,600	12,000	18,000	12,400	
115	12,400	11,200	14,800	12,800	16,000	12,800	17,200	12,800	17,200	12,400	17,600	12,000	18,000	12,400	
118	12,400	11,200	14,800	12,800	16,000	12,800	17,200	12,800	17,200	12,400	17,600	12,000	18,000	12,400	
020	50	13,900	12,100	16,400	13,900	18,900	14,600	20,000	15,400	20,700	15,400	22,500	15,700	23,900	15,000
	54	13,900	12,100	16,400	13,900	18,900	14,600	20,000	15,400	20,700	15,400	22,500	15,700	23,900	15,000
	58	13,900	12,100	16,400	13,900	18,900	14,600	20,000	15,400	20,700	15,400	22,100	15,400	23,900	15,000
	60	13,900	12,100	16,400	13,900	18,900	14,600	20,000	15,400	20,700	15,400	22,100	15,400	23,600	14,600
	64	13,900	12,100	16,400	13,900	18,900	14,600	20,000	15,400	20,700	15,400	22,100	15,400	23,600	14,600
	67	13,900	12,100	16,400	13,900	18,900	14,600	20,000	15,400	20,700	15,400	22,100	15,400	23,600	14,600
	70	13,900	12,100	16,400	13,900	18,900	14,600	20,000	15,400	20,700	15,400	22,100	15,400	23,600	14,600
	73	13,900	12,100	16,400	13,900	18,900	14,600	20,000	15,400	20,700	15,400	22,100	15,400	23,600	14,600
	77	13,900	12,100	16,400	13,900	18,900	14,600	20,000	15,400	20,700	15,400	22,100	15,400	23,600	14,600
	80	13,900	12,100	16,400	13,900	18,900	14,600	20,000	15,400	20,700	15,400	22,100	15,400	23,600	14,600
	84	13,900	12,100	16,400	13,900	18,900	14,600	20,000	15,400	20,700	15,400	22,100	15,400	23,600	14,600
	88	13,900	12,100	16,400	13,900	18,900	14,600	20,000	15,400	20,700	15,400	22,100	15,400	23,600	14,600
	92	13,900	12,100	16,400	13,900	18,900	14,600	20,000	15,400	20,700	15,400	22,100	15,400	23,600	14,600
	95	13,900	12,100	16,400	13,900	18,900	14,600	20,000	15,400	20,700	15,400	22,100	15,400	23,600	14,600
	99	13,900	12,100	16,400	13,900	18,900	14,600	20,000	15,400	20,700	15,400	21,800	15,000	23,200	14,300
	103	13,900	12,100	16,400	13,900	18,900	14,600	20,000	15,400	20,700	15,400	21,800	15,000	22,900	13,900
107	13,900	12,100	16,400	13,900	18,900	14,600	19,300	15,000	20,000	15,000	20,700	14,600	21,400	13,200	
111	13,900	12,100	16,400	13,900	17,900	14,300	18,900	14,600	19,300	14,600	19,600	14,300	20,000	12,500	
115	13,900	12,100	16,400	13,900	17,900	14,300	18,900	14,600	19,300	14,600	19,600	14,300	20,000	12,500	
118	13,900	12,100	16,400	13,900	17,900	14,300	18,900	14,600	19,300	14,600	19,600	14,300	20,000	12,500	

**NOTE**

- The performance table shows the average value of each conditions.



# 3. Capacity Table

## Wind-Free 4Way Cassette (600x600)

Heating

TC : Total Capacity (kW)

Capacity Index	Outdoor Air Temp. (°F)		Indoor temperature (°F, WB)				
			61	65	70	72	75
	DB	WB	TC	TC	TC	TC	TC
005	-3.6	-4.0	3,700	3,700	3,700	3,700	3,700
	-1.8	-2.2	3,800	3,800	3,800	3,800	3,800
	2	1	4,000	4,000	4,000	4,000	4,000
	6	5	4,200	4,000	4,000	4,000	4,000
	10	9	4,400	4,400	4,400	4,400	4,200
	13	12	4,800	4,800	4,600	4,600	4,600
	17	15	5,300	5,100	4,900	4,800	4,800
	19	18	5,700	5,500	5,200	5,000	5,000
	23	21	5,900	5,700	5,500	5,300	5,300
	26	24	6,100	6,000	5,700	5,600	5,500
	30	28	6,300	6,200	5,900	5,700	5,500
	35	32	6,500	6,300	6,000	5,700	5,500
	39	36	6,700	6,400	6,000	5,700	5,500
	44	40	7,000	6,700	6,000	5,700	5,500
	47	43	7,000	6,700	6,000	5,700	5,500
51	47	7,400	6,700	6,000	5,700	5,500	
54	50	7,400	6,700	6,000	5,700	5,500	
57	53	7,400	6,700	6,000	5,700	5,500	
60	56	7,400	6,700	6,000	5,700	5,500	
007	-3.6	-4.0	5,400	5,400	5,400	5,400	5,400
	-1.8	-2.2	5,500	5,500	5,500	5,500	5,400
	2	1	5,700	5,700	5,700	5,600	5,500
	6	5	6,000	5,900	5,700	5,700	5,500
	10	9	6,200	6,200	6,100	6,000	5,900
	13	12	6,600	6,600	6,500	6,400	6,300
	17	15	7,000	6,900	6,800	6,700	6,600
	19	18	7,500	7,200	7,000	6,900	6,700
	23	21	7,700	7,500	7,300	7,200	7,100
	26	24	8,100	7,900	7,700	7,500	7,300
	30	28	8,400	8,200	7,900	7,700	7,500
	35	32	8,700	8,400	8,100	7,900	7,600
	39	36	8,900	8,700	8,200	8,000	7,700
	44	40	9,400	9,100	8,500	8,200	7,800
	47	43	9,600	9,200	8,700	8,300	7,800
51	47	10,000	9,400	8,700	8,300	7,800	
54	50	10,200	9,400	8,700	8,300	7,800	
57	53	10,300	9,500	8,700	8,300	7,800	
60	56	10,500	9,500	8,700	8,300	7,800	

# 3. Capacity Table

## Wind-Free 4Way Cassette (600x600)

Capacity Index	Outdoor Air Temp. (°F)		Indoor temperature (°F, WB)				
			61	65	70	72	75
	DB	WB	TC Btu/h	TC Btu/h	TC Btu/h	TC Btu/h	TC Btu/h
009	-3.6	-4	6,400	6,400	6,400	6,400	6,400
	-1.8	-2	6,600	6,600	6,600	6,600	6,400
	2	1	6,800	6,800	6,800	6,800	6,400
	6	5	7,100	7,100	6,800	6,800	6,400
	10	9	7,500	7,500	7,300	7,100	7,100
	13	12	7,800	7,800	7,800	7,800	7,500
	17	15	8,100	8,000	8,000	8,000	7,600
	19	18	8,500	8,100	8,100	8,100	7,800
	23	21	8,800	8,800	8,500	8,500	8,100
	26	24	9,500	9,100	9,000	8,800	8,500
	30	28	9,700	9,300	9,100	9,000	8,600
	35	32	9,800	9,500	9,300	9,100	8,800
	39	36	10,200	10,200	9,700	9,500	9,100
	44	40	10,800	10,500	10,200	9,800	9,100
	47	43	11,200	10,800	10,500	10,200	9,100
	51	47	11,500	11,200	10,500	10,200	9,100
54	50	11,900	11,200	10,500	10,200	9,100	
57	53	12,200	11,500	10,500	10,200	9,100	
60	56	12,500	11,500	10,500	10,200	9,100	
012	-3.6	-4	8,400	8,400	8,100	8,100	8,100
	-1.8	-2	8,800	8,600	8,200	8,200	8,100
	2	1	9,100	8,800	8,400	8,400	8,100
	6	5	9,500	9,100	8,800	8,800	8,400
	10	9	9,800	9,500	9,300	9,100	9,100
	13	12	10,200	10,200	10,000	9,800	9,800
	17	15	10,500	10,500	10,300	10,200	10,000
	19	18	10,900	10,900	10,500	10,500	10,200
	23	21	11,600	11,200	11,000	10,900	10,500
	26	24	11,900	11,900	11,400	11,200	10,900
	30	28	12,300	12,300	11,700	11,600	11,000
	35	32	12,600	12,600	12,100	11,900	11,200
	39	36	13,300	13,000	12,600	12,300	11,900
	44	40	13,700	13,700	13,000	12,600	11,900
	47	43	14,400	14,400	13,500	13,000	11,900
	51	47	14,700	14,400	13,500	13,000	11,900
54	50	15,400	14,700	13,500	13,000	11,900	
57	53	15,800	14,700	13,500	13,000	11,900	
60	56	16,100	15,100	13,500	13,000	11,900	

# 3. Capacity Table

## Wind-Free 4Way Cassette (600x600)

Capacity Index	Outdoor Air Temp. (°F)		Indoor temperature (°F, WB)				
			61	65	70	72	75
	DB	WB	TC	TC	TC	TC	TC
018	-3.6	-4	12,900	12,600	12,400	12,200	12,200
	-1.8	-2	13,100	12,900	12,600	12,400	12,400
	2	1	13,200	13,200	12,700	12,600	12,600
	6	5	13,900	13,600	13,100	12,900	12,600
	10	9	14,500	14,200	13,900	13,900	13,600
	13	12	15,200	15,200	14,700	14,500	14,500
	17	15	15,700	15,500	15,200	15,000	14,700
	19	18	16,200	15,900	15,700	15,500	14,900
	23	21	17,200	16,900	16,400	16,200	15,500
	26	24	17,900	17,500	17,200	16,900	16,200
	30	28	18,300	18,000	17,500	17,200	16,400
	35	32	18,800	18,500	17,900	17,500	16,500
	39	36	19,500	19,500	18,800	18,500	17,500
	44	40	20,500	20,200	19,300	18,800	17,500
	47	43	21,500	21,200	20,000	19,200	17,500
020	51	47	22,100	21,500	20,000	19,200	17,500
	54	50	22,800	21,800	20,000	19,200	17,500
	57	53	23,500	22,100	20,000	19,200	17,500
	60	56	24,100	22,500	20,000	19,200	17,500
	-3.6	-4	15,200	14,900	14,500	14,500	14,500
	-1.8	-2	15,400	15,000	14,700	14,700	14,500
	2	1	15,600	15,200	14,900	14,900	14,500
	6	5	16,300	15,900	15,000	14,900	14,500
	10	9	16,900	16,600	16,100	15,900	15,600
	13	12	17,600	17,600	17,100	16,900	16,900
	17	15	18,200	18,200	17,600	17,500	17,300
	19	18	18,700	18,700	18,200	18,000	17,600
	23	21	19,700	19,400	19,000	18,700	18,000
	26	24	20,800	20,400	19,900	19,400	18,700
	30	28	21,300	20,900	20,300	19,900	19,000
35	32	21,800	21,400	20,800	20,400	19,400	
39	36	22,800	22,500	21,800	21,400	20,400	
44	40	23,900	23,500	22,500	21,800	20,400	
47	43	24,900	24,600	23,000	22,500	20,400	
51	47	25,600	24,900	23,000	22,500	20,400	
54	50	26,300	25,200	23,000	22,500	20,400	
57	53	27,300	25,600	23,000	22,500	20,400	
60	56	28,000	25,900	23,000	22,500	20,400	

**NOTE**

- The performance table shows the average value of each conditions.

# 4. Dimensional Drawing

## Wind-Free 4Way Cassette (600x600)

AM005/007/009/012/018/020NNNDCH/AA

Units : mm [inches]

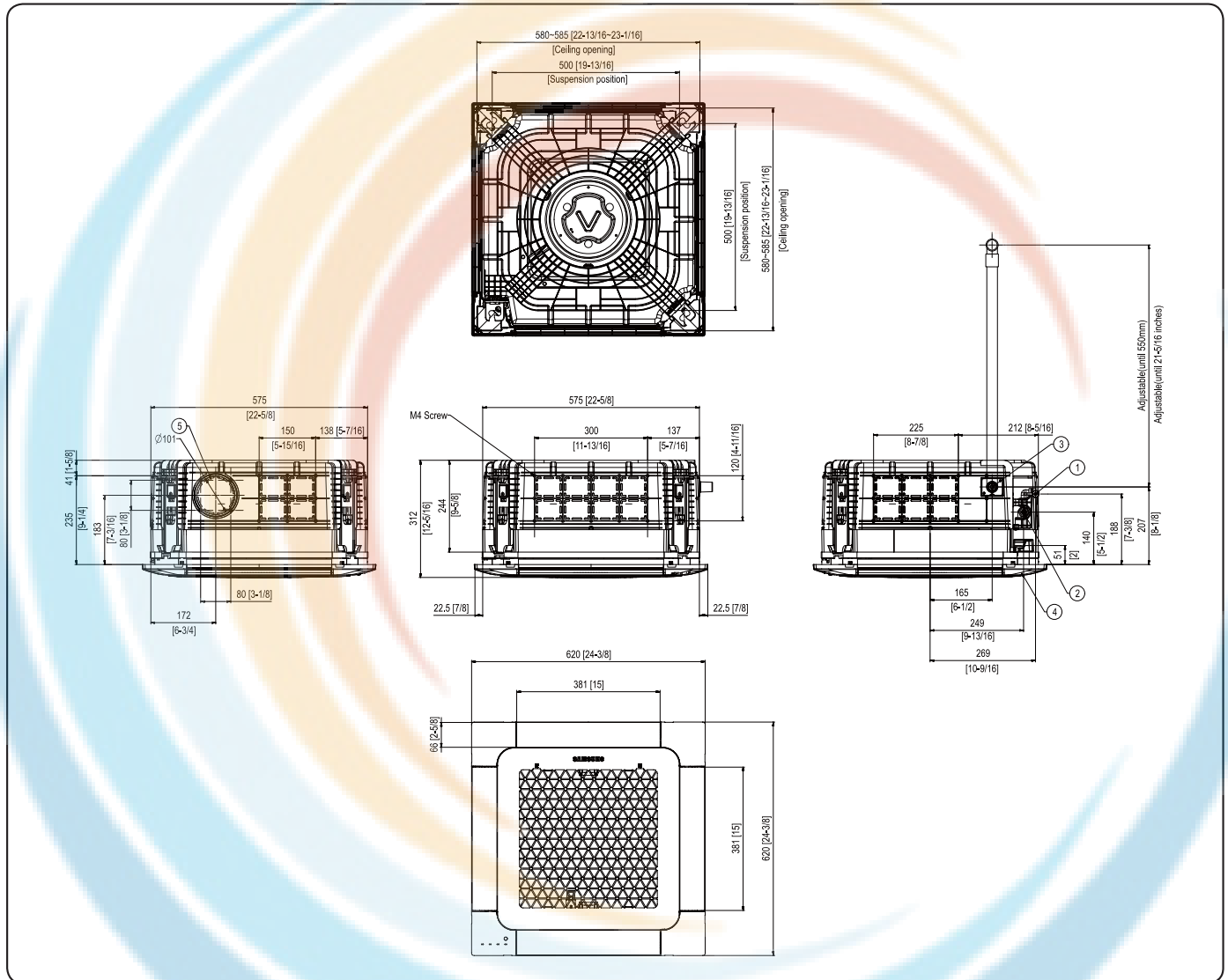

No.	Name	Description
1	Liquid pipe connection	$\Phi 6.35(1/4)$
2	Gas pipe connection	$\Phi 12.7(1/2)$
3	Drain pipe connection	VP-25(OD32, ID25)
4	Power supply & Communication wiring conduit	Use M4 Screw
5	Fresh air intake knockout hole	$\Phi 10[4]$ , Use M4 Screw

### NOTE

- As for suspension bolt, please use M8 ~ M10. (Procured at local site)



# 5. Center of Gravity

Wind-Free 4Way Cassette (600x600)

AM005/007/009/012/018/020NNNDCH/AA

Units : mm [inches]

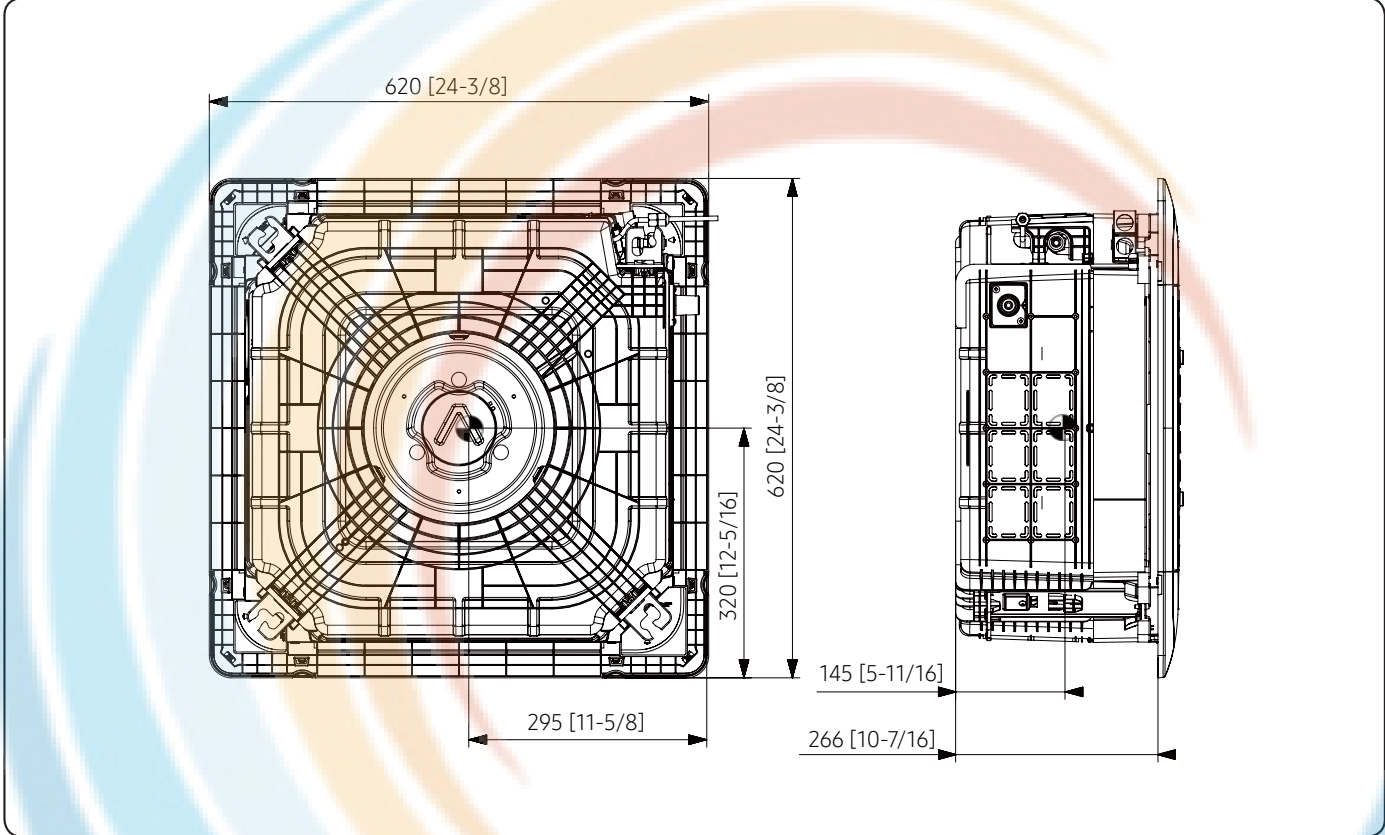

# 6. Electrical Wiring Diagram

Wind-Free 4Way Cassette (600x600)

AM005/007/009/012/018/020NNNDCH/AA

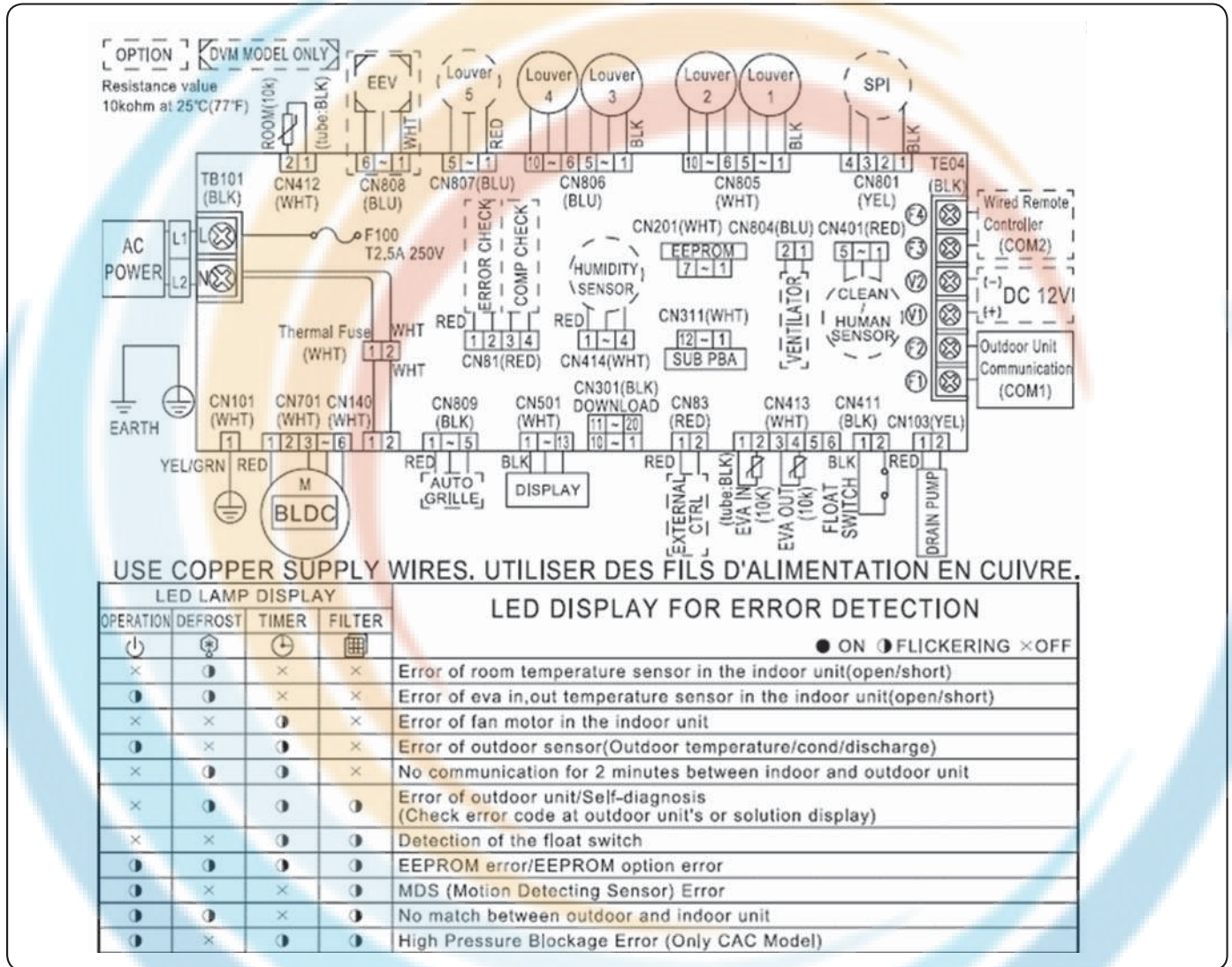

F100	FUSE	SPI	S-Plasma ion	ROOM(10K)	Thermistor ROOM OUT(10K)
M-BLDC	BLDC Motor	EEV	Electronic Expansion Valve	EVA-IN(10K)	Thermistor EVA IN(10K)
		EXT_CONTROL	EXTERNAL_CONTROL	EVA-OUT(10K)	Thermistor EVA OUT(10K)

## NOTE

- This wiring diagram applies only to the Indoor unit.
- Symbols show as follow :  
blk: black, red: red, blu: blue, wht: white, yel: yellow, brn: brown, sky: skyblue: grn: green
- For connection wiring indoor-outdoor transmission F1-F2, indoor-wired remote controller transmission F3-F4.
- ⚡ Protective earth(screw), □□□□ : connector,  $\frac{N}{x}$  : The wire quantity

# 7. Sound Data

## Wind-Free 4Way Cassette (600x600)

### Sound Pressure level

Unit: dB(A)

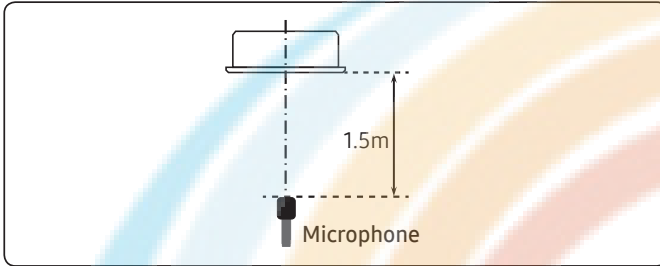

Model	High	MID	LOW
AM005NNNDCH/AA	30	28	23
AM007NNNDCH/AA	32	29	25
AM009NNNDCH/AA	33	30	26
AM012NNNDCH/AA	34	30	26

- NC Curve

1) AM005NNNDCH/AA

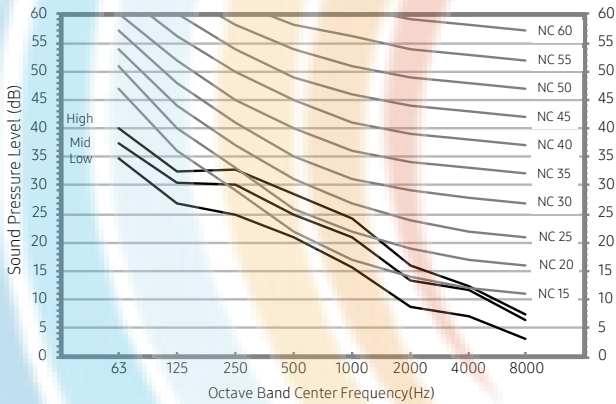

2) AM007NNNDCH/AA

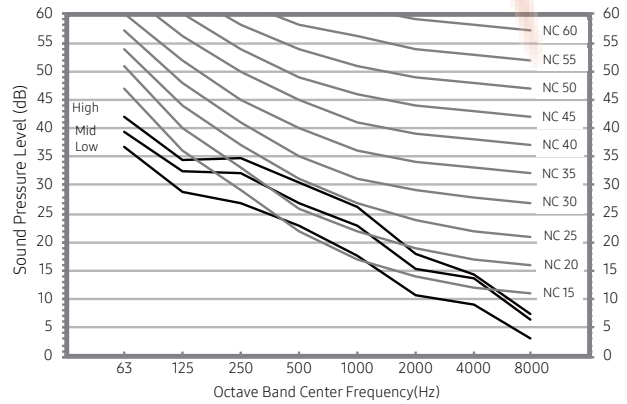

3) AM009NNNDCH/AA

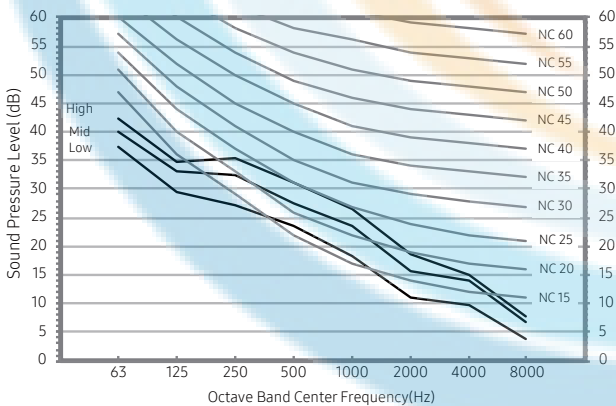

4) AM012NNNDCH/AA

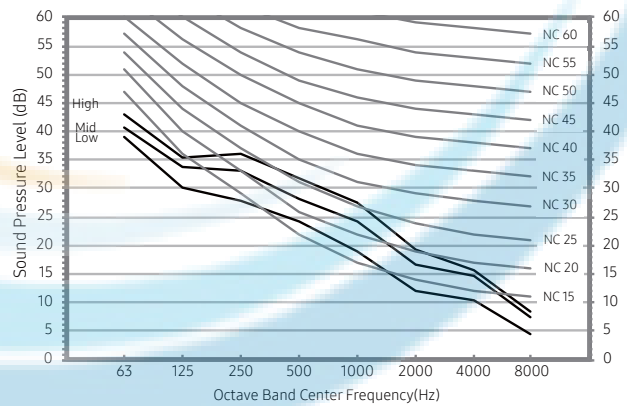

### NOTE

- Specifications may be subject to change without prior notice.
  - Sound pressure level is obtained in an anechoic room.
  - Sound pressure level is a relative value, depending on the distance and acoustic environment.
  - Sound pressure level may differ depending on operation condition.
  - dBA = A weighted sound pressure level
  - Reference acoustic pressure 0 dB = 20μPa

# 7. Sound Data

## Wind-Free 4Way Cassette (600x600)

### Sound Pressure level

Unit: dB(A)

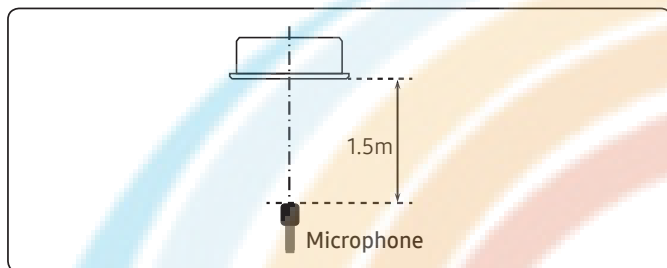

Model	High	MID	LOW
AM018NNNDCH/AA	39	36	33
AM020NNNDCH/AA	40	38	35

- NC Curve

5) AM018NNNDCH/AA

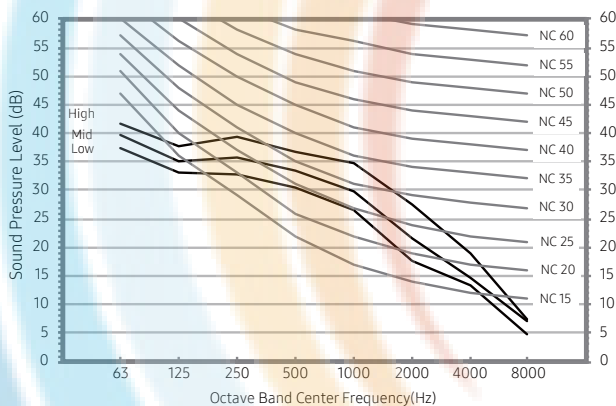

6) AM020NNNDCH/AA

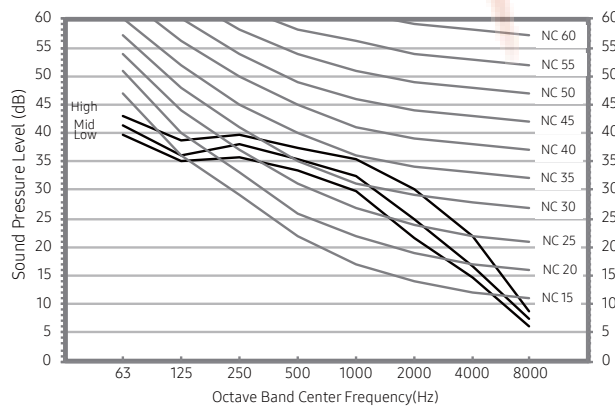

**NOTE**

- Specifications may be subject to change without prior notice.
  - Sound pressure level is obtained in an anechoic room.
  - Sound pressure level is a relative value, depending on the distance and acoustic environment.
  - Sound pressure level may differ depending on operation condition.
  - dBA = A weighted sound pressure level
  - Reference acoustic pressure 0 dB = 20μPa

# 7. Sound Data

## Wind-Free 4Way Cassette (600x600)

### Sound Power level

**NOTE**

Unit: dB(A)

- Specifications may be subject to change without prior notice
  - Sound power level is an absolute value that a sound source generates.
  - dBA = A-weighted sound power level.
  - Reference power : 1pW.
  - Measured according to ISO 3741.

Model	Power
AM005NNNDCH/AA	46
AM007NNNDCH/AA	47
AM009NNNDCH/AA	50
AM012NNNDCH/AA	51

• NC Curve

1) AM005NNNDCH/AA

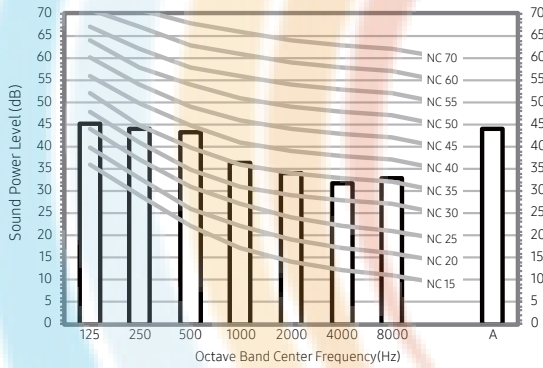

2) AM007NNNDCH/AA

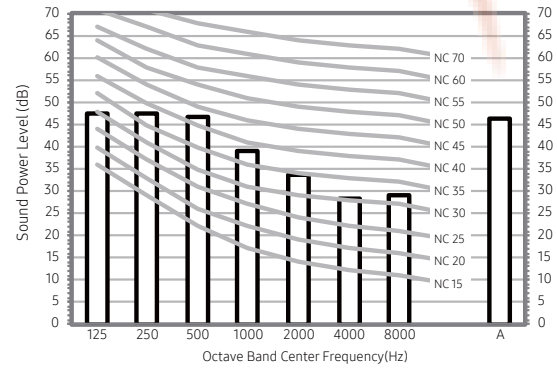

3) AM009NNNDCH/AA

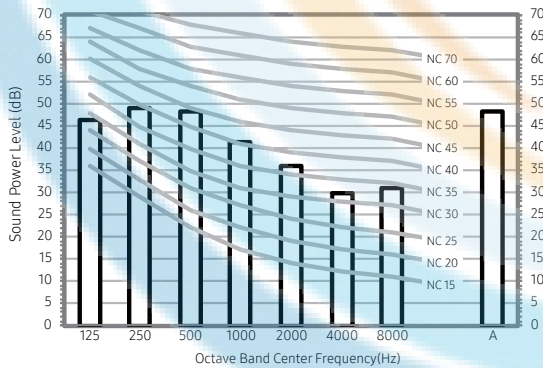

4) AM012NNNDCH/AA

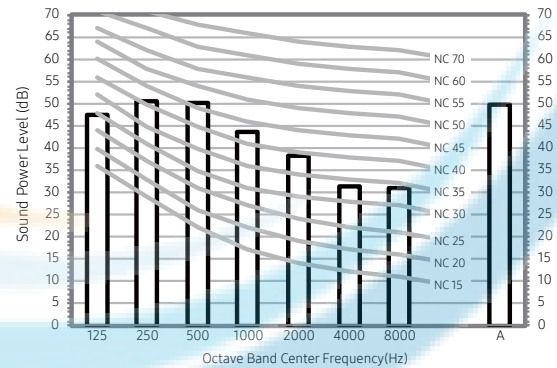

# 7. Sound Data

## Wind-Free 4Way Cassette (600x600)

### Sound Power level

**NOTE**

Unit: dB(A)

- Specifications may be subject to change without prior notice
  - Sound power level is an absolute value that a sound source generates.
  - dBA = A-weighted sound power level.
  - Reference power : 1pW.
  - Measured according to ISO 3741.

Model	Power
AM018NNNDCH/AA	56
AM020NNNDCH/AA	57

• NC Curve

5) AM018NNNDCH/AA

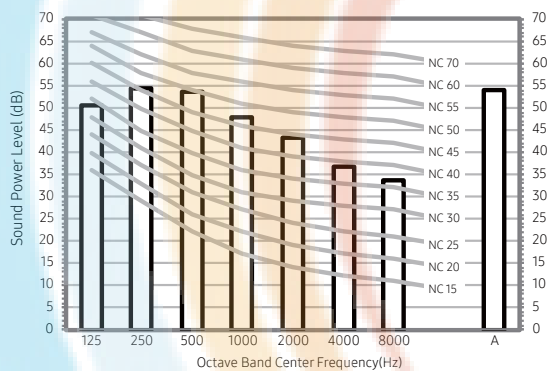

6) AM020NNNDCH/AA

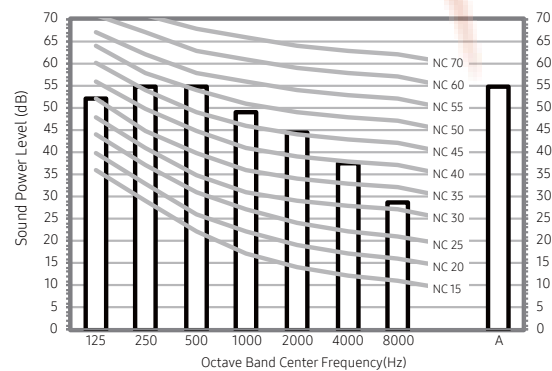



# 8. Temperature and air flow distribution

## Wind-Free 4Way Cassette (600x600)

### AM005NNNDCH/AA

- Cooling Air Velocity distribution  
Discharge angle : 41°

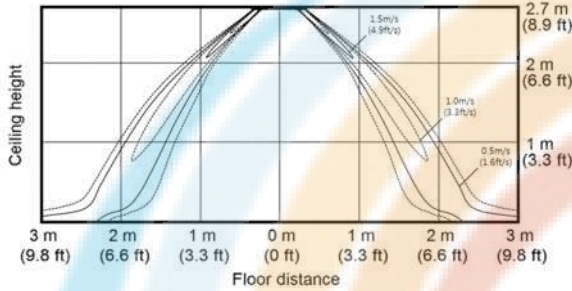

- Cooling Temperature distribution  
Discharge angle : 41°

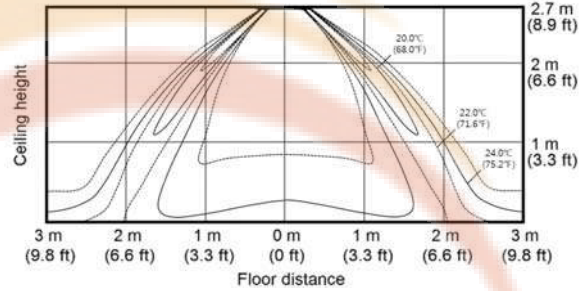

- Heating Air Velocity distribution  
Discharge angle : 56°

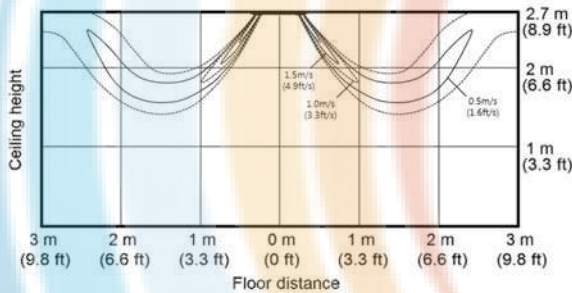

- Heating Temperature distribution  
Discharge angle : 56°

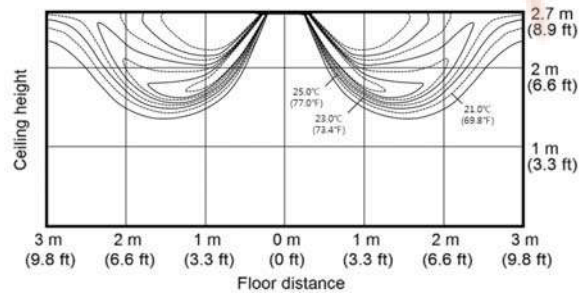

### AM007NNNDCH/AA

- Cooling Air Velocity distribution  
Discharge angle : 41°

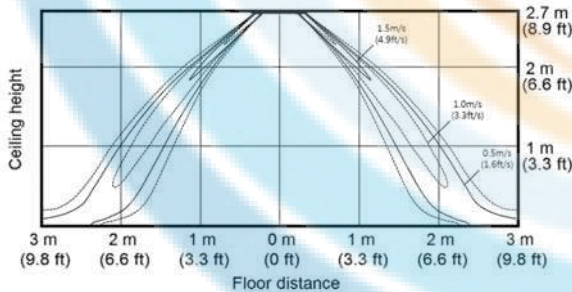

- Cooling Temperature distribution  
Discharge angle : 41°

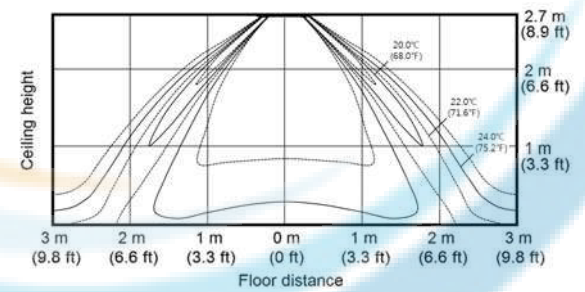

- Heating Air Velocity distribution  
Discharge angle : 56°

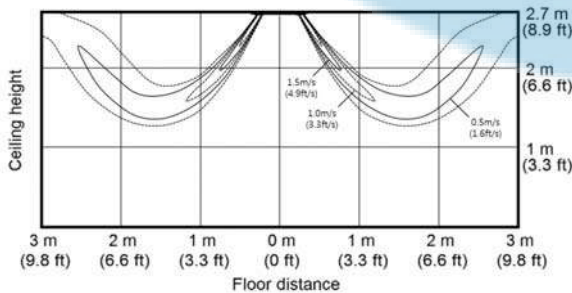

- Heating Temperature distribution  
Discharge angle : 56°

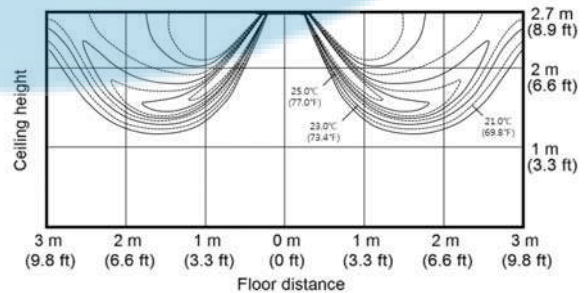

# 8. Temperature and air flow distribution

## Wind-Free 4Way Cassette (600x600)

### AM009NNNDCH/AA

- Cooling Air Velocity distribution

Discharge angle : 41°

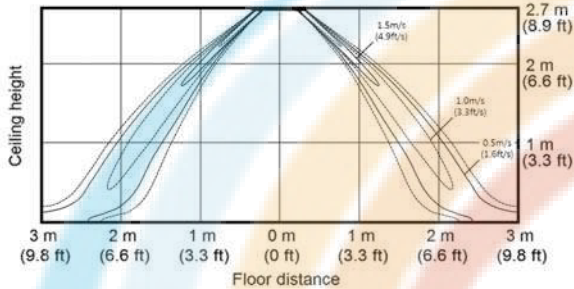

- Cooling Temperature distribution

Discharge angle : 41°

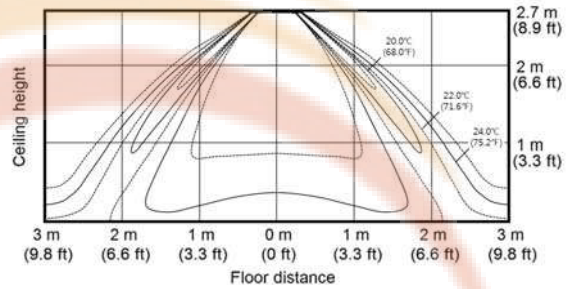

- Heating Air Velocity distribution

Discharge angle : 56°

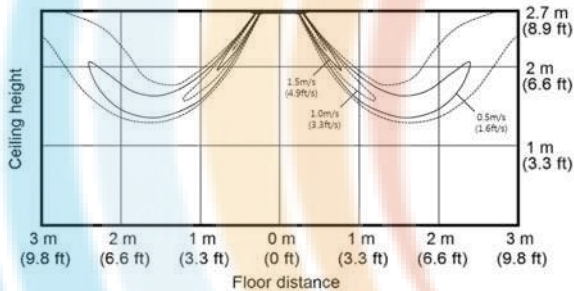

- Heating Temperature distribution

Discharge angle : 56°

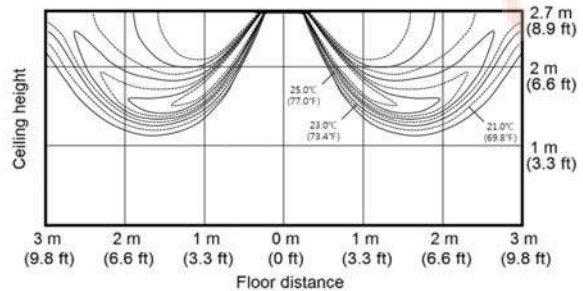

### AM012NNNDCH/AA

- Cooling Air Velocity distribution

Discharge angle : 41°

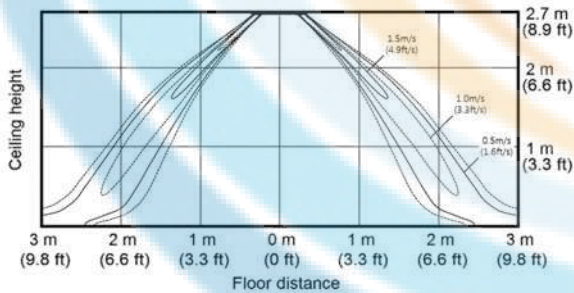

- Cooling Temperature distribution

Discharge angle : 41°

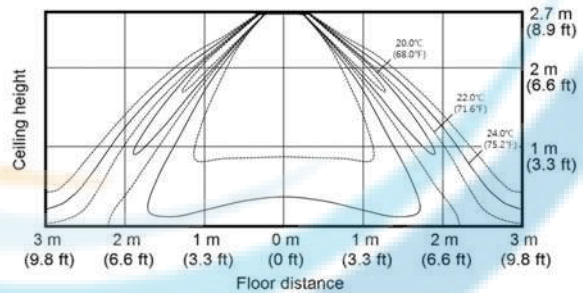

- Heating Air Velocity distribution

Discharge angle : 56°

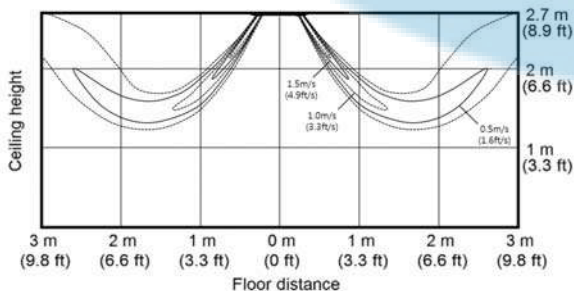

- Heating Temperature distribution

Discharge angle : 56°

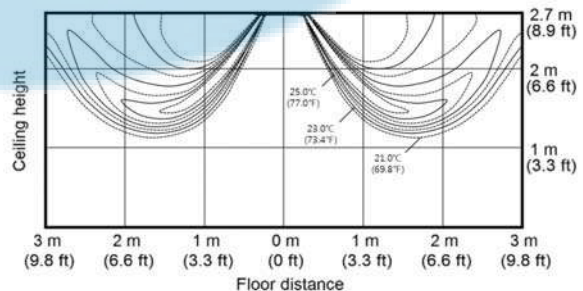

# 8. Temperature and air flow distribution

## Wind-Free 4Way Cassette (600x600)

### AM018NNNDCH/AA

- Cooling Air Velocity distribution  
Discharge angle : 41°

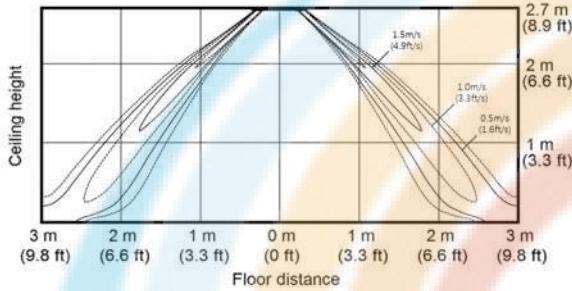

- Cooling Temperature distribution  
Discharge angle : 41°

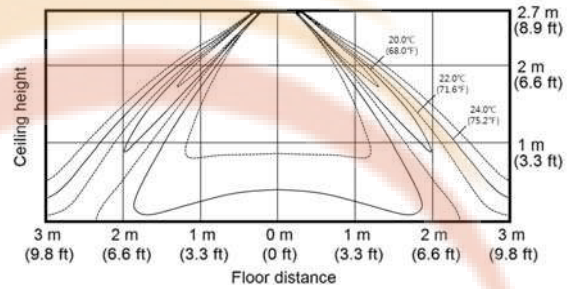

- Heating Air Velocity distribution  
Discharge angle : 56°

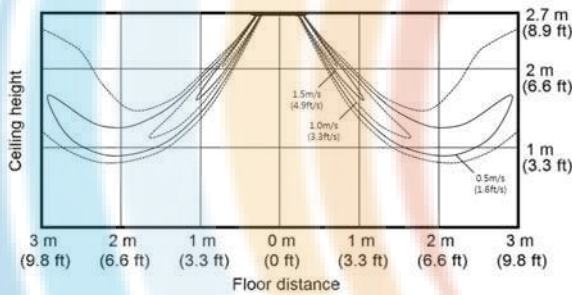

- Heating Temperature distribution  
Discharge angle : 56°

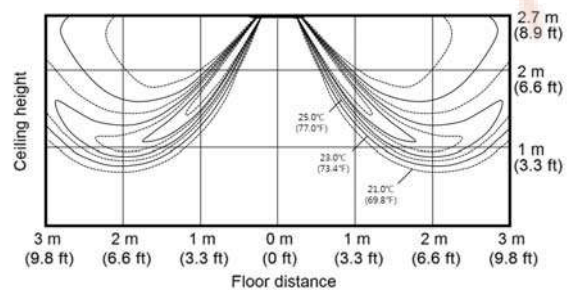

### AM020NNNDCH/AA

- Cooling Air Velocity distribution  
Discharge angle : 41°

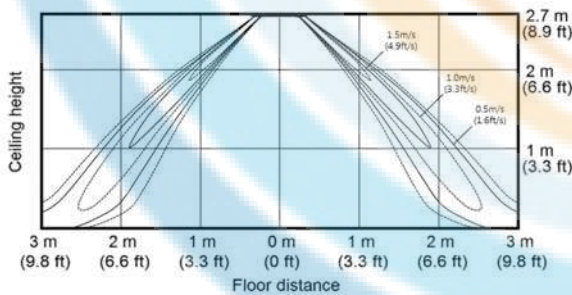

- Cooling Temperature distribution  
Discharge angle : 41°

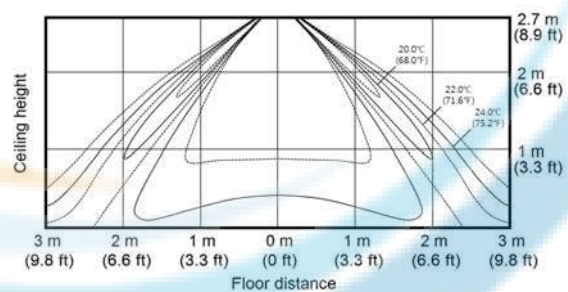

- Heating Air Velocity distribution  
Discharge angle : 56°

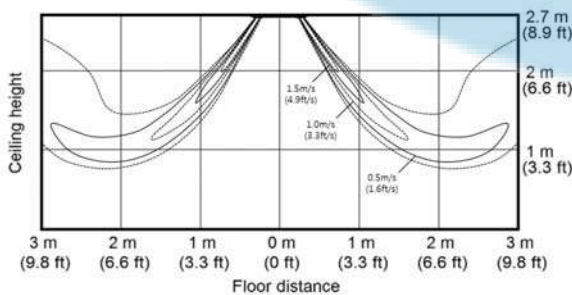

- Heating Temperature distribution  
Discharge angle : 56°

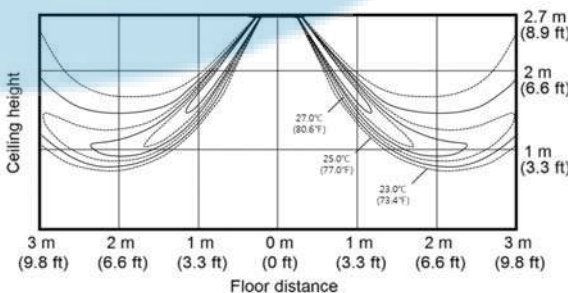

# 9. Piping Diagram

## Wind-Free 4Way Cassette (600x600)

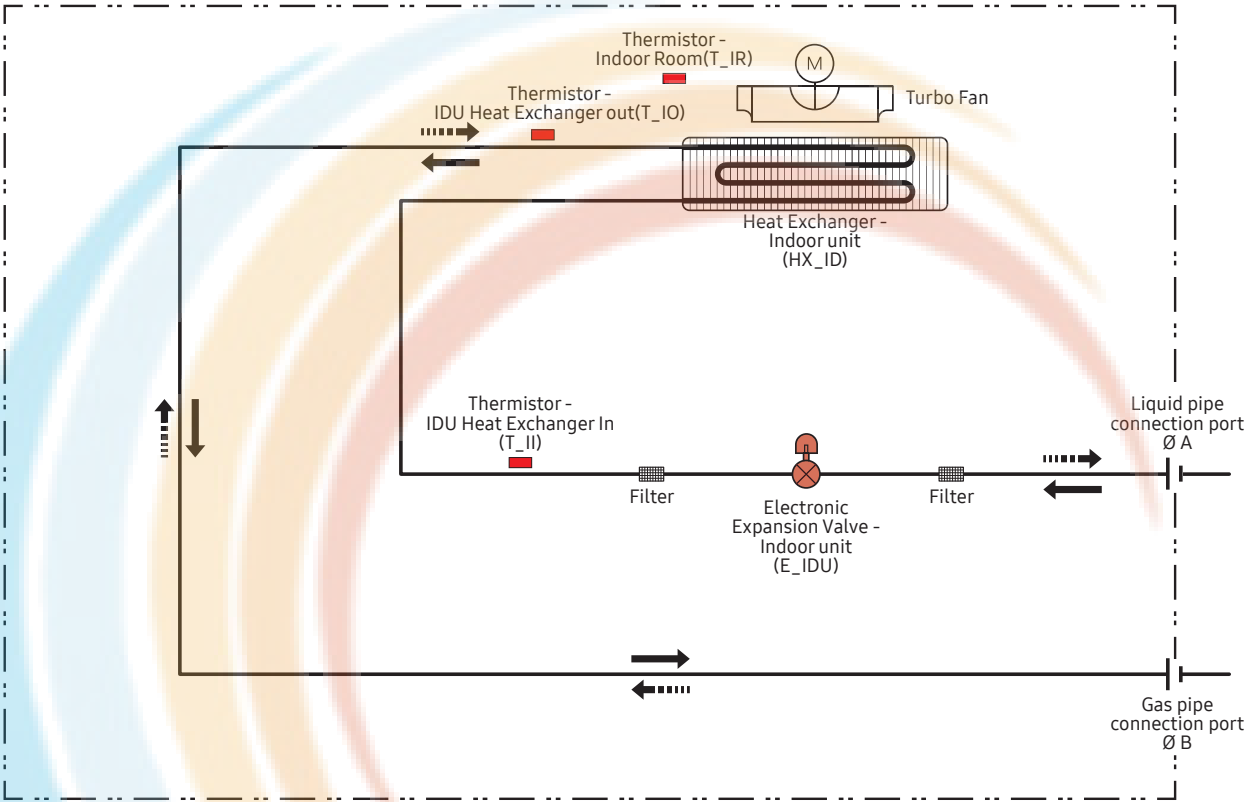

Refrigerant flow	
Cooling	Heating
→	⋯→

Unit : inches

Model	High	Mid
AM005NNNDCH/AA	1/4"	1/2"
AM007NNNDCH/AA		
AM009NNNDCH/AA		
AM012NNNDCH/AA		
AM018NNNDCH/AA		
AM020NNNDCH/AA		

# Wind-Free 4Way Cassette

---

1. Specification	33
2. Summary Table	37
3. Capacity Table	38
4. Dimensional Drawing	45
5. Center of Gravity	47
6. Electrical Wiring Diagram	48
7. Sound Data	49
8. Temperature and air flow distribution	53
9. Piping Diagram	57

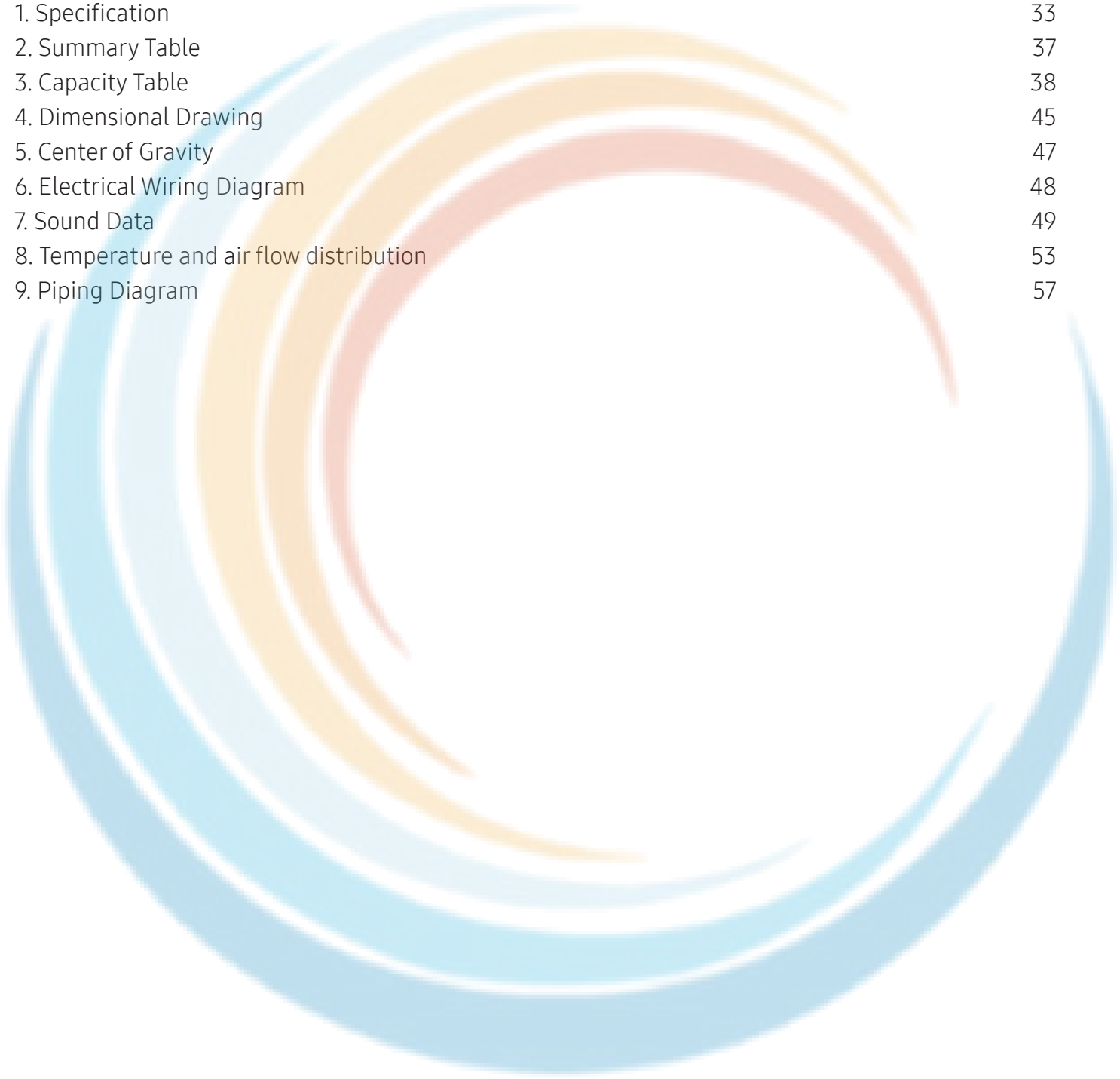



# Features & Benefits

## Stage a beautiful yet comfortable environment

With its newly improved design, Wind-Free 4Way Cassette supports a clean, aesthetically appealing atmosphere and adds a sense of sophistication to work and living spaces. Not only is this unit attractively designed, but it also uses advanced technologies to optimize comfort in any environment.

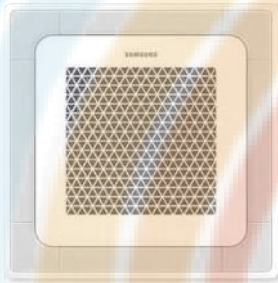

The Samsung Wind-Free 4Way Cassette indoor air conditioning system delivers polish, comfort and efficiency with features such as:

- **Stylishly clean design.** Add panache to interior spaces with a choice of clean, streamlined panel patterns in a lightweight build.
- **Robust operation.** Control the atmosphere perfectly with an advanced design for superior air flow and cooling/heating performance.
- **Low maintenance and simple installation.** Ease installation and minimize maintenance with a detachable, no-drip design.

## Wind-Free 4Way Cassette - Stylishly clean design

### Aesthetic panel and display

Wind-Free 4Way Cassette offers two different pattern designs for the panel. The simple display design with rounded corners adds a chic sophistication to the interior.

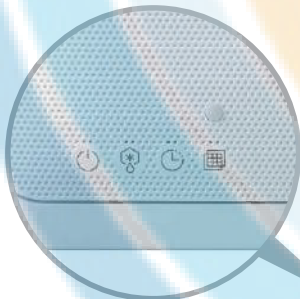

Power Defrost Time Clean

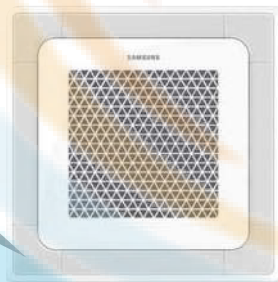

### Neat and clean design

The indoor Wind-Free 4Way Cassette boasts a smart design that promotes a neat and clean look. The completely hermetic blade structure keeps the indoor unit clean by preventing dust or other foreign substances from entering it. The internal parts of the indoor unit are also out of sight when the blade is shut, thus improving the unit's appearance.

### Lightweight build

The Samsung Wind-Free 4Way Cassette indoor unit is now lighter in weight at 16.5kg is one of the lightest indoor units in the industry, about 40 percent lighter than conventional products.

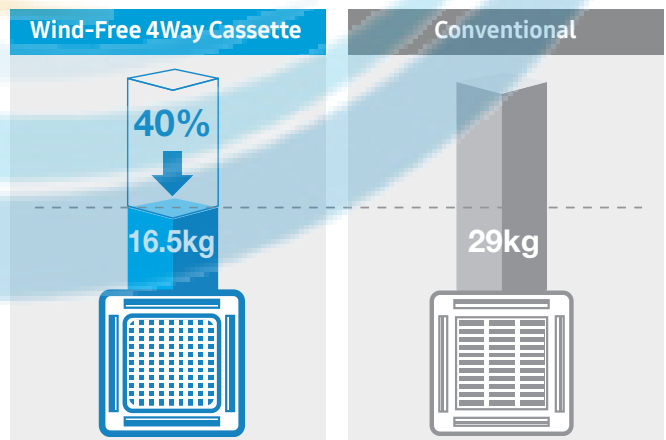

\*Based on 11.2kW



# 1. Specification

## Wind-Free 4Way Cassette

Type			4Way CASSETTE	4Way CASSETTE	4Way CASSETTE	4Way CASSETTE	
Model Name			AM009NN4DCH/AA	AM012NN4DCH/AA	AM018NN4DCH/AA	AM024NN4DCH/AA	
Power Supply			Φ, #, V, Hz	1,2,208-230,60	1,2,208-230,60	1,2,208-230,60	
Mode			-	HP/HR	HP/HR	HP/HR	
Performance	TON		Ton	0.75	1	1.5	2
		Capacity	Cooling	kW	2.64	3.52	5.28
	Btu/h			9,000	12,000	18,000	24,000
	Heating		USRT	0.75	1	1.5	2
			kW	2.93	3.96	5.86	7.91
	Btu/h	10,000	13,500	20,000	27,000		
USRT	0.83	1.13	1.67	2.25			
Power	Power Input	Cooling	W	32.00	32.00	32.00	40.00
				Heating	32.00	32.00	32.00
	Current Input	Cooling	A	0.25	0.25	0.25	0.30
				Heating	0.25	0.25	0.25
	Current	MCA	A	0.35	0.35	0.35	0.35
MOP				15	15	15	15
Heat exchanger	Type		-	Fin & tube	Fin & tube	Fin & tube	Fin & tube
	Material	Fin	-	Al	Al	Al	Al
		Tube	-	Cu	Cu	Cu	Cu
	Fin Treatment		-	Slit-Fin*Hydrophilic	Slit-Fin*Hydrophilic	Slit-Fin*Hydrophilic	Slit-Fin*Hydrophilic
Fan	Type		-	Turbo Fan	Turbo Fan	Turbo Fan	Turbo Fan
	Quantity		EA	1	2	3	4
	Air Flow Rate	H/M/L	m <sup>3</sup> /min	15.50 / 14.00 / 12.00	15.50 / 14.00 / 12.00	15.50 / 14.00 / 12.00	17.50 / 16.00 / 14.00
			ft <sup>3</sup> /min	547 / 494 / 424	547 / 494 / 424	547 / 494 / 424	618 / 565 / 494
			l/s	258/233/200	258/233/200	258/233/200	291/266/233
	External Pressure	Max. (Min/Std/Max)	mmAq	-	-	-	-
Pa			-	-	-	-	
In Wg			-	-	-	-	
Fan Motor	Type		-	BLDC	BLDC	BLDC	BLDC
	Output x n		W	65 x 1	65 x 1	65 x 1	65 x 1
Piping Connections	Liquid Pipe	Type		Flare connection	Flare connection	Flare connection	Flare connection
		Φ, mm (inch)		6.35 (1/4)	6.35 (1/4)	6.35 (1/4)	9.52 (3/8)
	Gas Pipe	Type		0	0	0	0
		Φ, mm (inch)		12.70 (1/2)	12.70 (1/2)	12.70 (1/2)	15.88 (5/8)
	Heat insulation		-				
Drain Pipe	Φ,mm		VP25 (OD 32,ID 25)	VP25 (OD 32,ID 25)	VP25 (OD 32,ID 25)	VP25 (OD 32,ID 25)	
Wiring connections	Communication	Min.	mm <sup>2</sup>	2 X 16 AWG SHIELDED	2 X 16 AWG SHIELDED	2 X 16 AWG SHIELDED	2 X 16 AWG SHIELDED
		Remark		-			
Refrigerant	Type		-	R410A	R410A	R410A	R410A
	Electronic Expansion Valve		-	EEV INCLUDED	EEV INCLUDED	EEV INCLUDED	EEV INCLUDED
Sound	Sound Pressure Level	H/M/L	dB(A)	32/30/28	32/30/28	32/30/28	35/32/28
	Sound Power	Cooling		49	49	49	56
External Dimension	Net Weight		kg (lbs)	15	15	15	15
	Shipping Weight		kg (lbs)	18.5	18.5	18.5	18.5
	Net Dimensions (WxHxD)		mm	840 x 204 x 840	840 x 204 x 840	840 x 204 x 840	840 x 204 x 840
			inch	33 1/16 x 8 1/16 x 33 1/16	33 1/16 x 8 1/16 x 33 1/16	33 1/16 x 8 1/16 x 33 1/16	33 1/16 x 8 1/16 x 33 1/16
	Shipping Dimensions (WxHxD)		mm	898 x 275 x 898	898 x 275 x 898	898 x 275 x 898	898 x 275 x 898
		inch	35 3/8 x 10 13/16 x 35 3/8	35 3/8 x 10 13/16 x 35 3/8	35 3/8 x 10 13/16 x 35 3/8	35 3/8 x 10 13/16 x 35 3/8	

# 1. Specification

## Wind-Free 4Way Cassette

Type			4Way CASSETTE	4Way CASSETTE	4Way CASSETTE	4Way CASSETTE	
Model Name			AM009NN4DCH/AA	AM012NN4DCH/AA	AM018NN4DCH/AA	AM024NN4DCH/AA	
Casing	Material	-	HIPS	HIPS	HIPS	HIPS	
Panel	Model Name	-	PC4NUFMAN PC4NUFMUN	PC4NUFMAN PC4NUFMUN	PC4NUFMAN PC4NUFMUN	PC4NUFMAN PC4NUFMUN	
	Type	-	Wind Free Type	Wind Free Type	Wind Free Type	Wind Free Type	
	Material	-	HIPS	HIPS	HIPS	HIPS	
	Color	-	White	White	White	White	
	Net Weight	kg (lbs)	6.3	6.3	6.3	6.3	
	Shipping Weight	kg (lbs)	8.7	8.7	8.7	8.7	
	Net Dimensions (W×H×D)	mm		950 x 64 x 950	950 x 64 x 950	950 x 64 x 950	950 x 64 x 950
		inch		37 3/8 x 2 1/2 x 37 3/8	37 3/8 x 2 1/2 x 37 3/8	37 3/8 x 2 1/2 x 37 3/8	37 3/8 x 2 1/2 x 37 3/8
Shipping Dimensions (W×H×D)	mm		1,010 x 117 x 1,000	1,010 x 117 x 1,000	1,010 x 117 x 1,000	1,010 x 117 x 1,000	
	inch		39 3/4 x 4 5/8 x 39 3/4	39 3/4 x 4 5/8 x 39 3/4	39 3/4 x 4 5/8 x 39 3/4	39 3/4 x 4 5/8 x 39 3/4	
Drain Pump	Drain Pump	-	included	included	included	included	
	Max. lifting Height / Displacement	in / gal/h	29-5/16 6.34gal/h	29-5/16 6.34gal/h	29-5/16 6.34gal/h	29-5/16 6.34gal/h	
Additional Accessories	Drain Pump	External Model	-	-	-	-	
		Internal Model	-	-	-	-	
	Max. lifting Height / Displacement	in / gal/h	-	-	-	-	
Air Filter	-	Removable / Washable	Removable / Washable	Removable / Washable	Removable / Washable		

### NOTE

- Specification may be subject to change without prior notice.
  - 1) Mode : HP(Heat Pump), HR(Heat Recovery)
  - 2) Performances are based on the following test conditions.
    - Cooling : Indoor temperature : 80°F(26.7°C) DB, 67°F(19.4°C) WB, Outdoor temperature : 95°F(35°C) DB, 75°F(23.9°C) WB
    - Heating : Indoor temperature : 70°F(21.1°C) DB, 60°F(15.6°C) WB, Outdoor temperature : 47°F(8.3°C) DB, 43°F(6.1°C) WB
    - Equivalent refrigerant pipe length 25ft(7.5m), Level differences 0ft(0m)
  - 3) Sound pressure level is obtained in an anechoic room.
    - Sound pressure level is a relative value, depending on the distance and acoustic environment.
    - Sound pressure level may differ depending on operation condition.
    - dBA = A-weighted sound pressure level
    - Reference acoustic pressure 0 dB = 20uPa
  - 4) Sound power level is an absolute value that a sound source generates.
    - dBA = A-weighted sound power level
    - Reference power : 1pW
    - Measured according to ISO 3741
  - 5) These products contain R410A which is fluorinated greenhouse gas.
  - 6) Select wire size based on the value of MCA

# 1. Specification

## Wind-Free 4Way Cassette

Type			4Way CASSETTE	4Way CASSETTE	4Way CASSETTE		
Model Name			AM030NN4DCH/AA	AM036NN4DCH/AA	AM048NN4DCH/AA		
Power Supply			Φ, #, V, Hz	1,2,208-230,60	1,2,208-230,60		
Mode			-	HP/HR	HP/HR		
Performance	TON		Ton	2.5	3	4	
			kW	8.79	10.55	14.07	
	Capacity	Cooling		Btu/h	30,000	36,000	48,000
				US RT	2.5	3	4
				kW	9.96	11.72	15.83
	Heating		Btu/h	34,000	40,000	54,000	
			US RT	2.83	3.33	4.5	
		kW	9.96	11.72	15.83		
Power	Power Input	Cooling	W	65.00	75.00	95.00	
		Heating	W	65.00	75.00	95.00	
	Current Input	Cooling	A	0.50	0.56	0.75	
		Heating	A	0.50	0.56	0.75	
	Current	MCA	A	0.35	0.35	0.35	
		MOP	A	15	15	15	
Heat exchanger	Type		-	Fin & tube	Fin & tube	Fin & tube	
	Material	Fin	-	Al	Al	Al	
		Tube	-	Cu	Cu	Cu	
	Fin Treatment		-	Slit-Fin*Hydrophilic	Slit-Fin*Hydrophilic	Slit-Fin*Hydrophilic	
Fan	Type		-	Turbo Fan	Turbo Fan	Turbo Fan	
	Quantity		EA	5	6	6	
	Air Flow Rate	H/M/L		m <sup>3</sup> /min	22.00 / 19.50 / 17.00	24.00 / 22.00 / 20.00	29.00 / 27.00 / 24.00
				ft <sup>3</sup> /min	777 / 687 / 600	845 / 777 / 706	1024 / 953 / 845
				l/s	367/235/283	400/367/333	483/450/400
	External Pressure	Max. (Min/Std/Max)		mmAq	-	-	-
				Pa	-	-	-
			In Wg	-	-	-	
Fan Motor	Type		-	BLDC	BLDC	BLDC	
	Output x n		W	97 x 1	97 x 1	97 x 1	
Piping Connections	Liquid Pipe	Type		Flare connection	Flare connection	Flare connection	
		Φ, mm (inch)		9.52 (3/8)	9.52 (3/8)	9.52 (3/8)	
	Gas Pipe	Type		0	0	0	
		Φ, mm (inch)		15.88 (5/8)	15.88 (5/8)	15.88 (5/8)	
	Heat insulation		-				
Drain Pipe		Φ,mm	VP25 (OD 32,ID 25)	VP25 (OD 32,ID 25)	VP25 (OD 32,ID 25)		
Wiring connections	Communication	Min.	mm <sup>2</sup>	2 X 16 AWG SHIELDED	2 X 16 AWG SHIELDED	2 X 16 AWG SHIELDED	
		Remark		-			
Refrigerant	Type		-	R410A	R410A	R410A	
	Electronic Expansion Valve		-	EEV INCLUDED	EEV INCLUDED	EEV INCLUDED	
Sound	Sound Pressure Level	H/M/L	dB(A)	41/37/31	42/39/36	45/42/39	
	Sound Power	Cooling		57	58	60	
External Dimension	Net Weight		kg (lbs)	16.5	18.5	18.5	
	Shipping Weight		kg (lbs)	20	22.5	22.5	
	Net Dimensions (WxHxD)		mm	840 x 288 x 840	840 x 288 x 840	840 x 288 x 840	
			inch	33 1/16 x 8 1/16 x 33 1/16	33 1/16 x 8 1/16 x 33 1/16	33 1/16 x 8 1/16 x 33 1/16	
	Shipping Dimensions (WxHxD)		mm	898 x 357 x 898	898 x 357 x 898	898 x 357 x 898	
			inch	35 3/8 x 10 13/16 x 35 3/8	35 3/8 x 10 13/16 x 35 3/8	35 3/8 x 10 13/16 x 35 3/8	

# 1. Specification

## Wind-Free 4Way Cassette

Type			4Way CASSETTE	4Way CASSETTE	4Way CASSETTE	
Model Name			AM030NN4DCH/AA	AM036NN4DCH/AA	AM048NN4DCH/AA	
Casing	Material	-	HIPS	HIPS	HIPS	
Panel	Model Name	-	PC4NUFMAN PC4NUFMUN	PC4NUFMAN PC4NUFMUN	PC4NUFMAN PC4NUFMUN	
	Type	-	Wind Free Type	Wind Free Type	Wind Free Type	
	Material	-	HIPS	HIPS	HIPS	
	Color	-	White	White	White	
	Net Weight	kg (lbs)	6.3	6.3	6.3	
	Shipping Weight	kg (lbs)	8.7	8.7	8.7	
	Net Dimensions (W×H×D)	mm		950 x 64 x 950	950 x 64 x 950	950 x 64 x 950
		inch		37 3/8 x 2 1/2 x 37 3/8	37 3/8 x 2 1/2 x 37 3/8	37 3/8 x 2 1/2 x 37 3/8
	Shipping Dimensions (W×H×D)	mm		1,010 x 117 x 1,000	1,010 x 117 x 1,000	1,010 x 117 x 1,000
inch			39 3/4 x 4 5/8 x 39 3/4	39 3/4 x 4 5/8 x 39 3/4	39 3/4 x 4 5/8 x 39 3/4	
Drain Pump	Drain Pump	-	included	included	included	
	Max. lifting Height / Displacement	in / gal/h	29-5/16 6.34gal/h	29-5/16 6.34gal/h	29-5/16 6.34gal/h	
Additional Accessories	Drain Pump	External Model	-	-	-	
		Internal Model	-	-	-	
		Max. lifting Height / Displacement	in / gal/h	-	-	-
	Air Filter	-	Removable / Washable	Removable / Washable	Removable / Washable	

### NOTE

- Specification may be subject to change without prior notice.
  - 1) Mode : HP(Heat Pump), HR(Heat Recovery)
  - 2) Performances are based on the following test conditions.
    - Cooling : Indoor temperature : 80°F(26.7°C) DB, 67°F(19.4°C) WB, Outdoor temperature : 95°F(35°C) DB, 75°F(23.9°C) WB
    - Heating : Indoor temperature : 70°F(21.1°C) DB, 60°F(15.6°C) WB, Outdoor temperature : 47°F(8.3°C) DB, 43°F(6.1°C) WB
    - Equivalent refrigerant pipe length 25ft(7.5m), Level differences 0ft(0m)
  - 3) Sound pressure level is obtained in an anechoic room.
    - Sound pressure level is a relative value, depending on the distance and acoustic environment.
    - Sound pressure level may differ depending on operation condition.
    - dBA = A-weighted sound pressure level
    - Reference acoustic pressure 0 dB = 20uPa
  - 4) Sound power level is an absolute value that a sound source generates.
    - dBA = A-weighted sound power level
    - Reference power : 1pW
    - Measured according to ISO 3741
  - 5) These products contain R410A which is fluorinated greenhouse gas.
  - 6) Select wire size based on the value of MCA

## 2. Summary Table

### Wind-Free 4Way Cassette

#### Performance Characteristics

Model Code	Net Weight (lbs)	Fan Speed	Capacity			Airflow (CFM)	Sound Pressure (dBA)	Sound Power (dBA)
			Cooling (Btu/h)	Sensible (Btu/h)	Heating (Btu/h)			
AM009NN4DCH/AA	33.1	High	9000	6600	10000	547.5	32	49
		Mid	6000	5000	9500	494.5	30	
		Low	4400	3800	8800	423.8	28	
AM012NN4DCH/AA	33.1	High	12000	9000	13500	547.5	32	49
		Mid	8000	6600	12800	494.5	30	
		Low	5800	5100	11900	423.8	28	
AM018NN4DCH/AA	33.1	High	18000	13700	20000	547.5	32	49
		Mid	12000	10000	19000	494.5	30	
		Low	8700	7700	17600	423.8	28	
AM024NN4DCH/AA	33.1	High	24000	19000	27000	618.1	35	56
		Mid	16000	13500	25800	565.1	32	
		Low	11800	10500	24100	494.5	28	
AM030NN4DCH/AA	36.4	High	30000	23000	34000	777.0	41	57
		Mid	19700	16600	32000	688.7	37	
		Low	14500	13000	29900	600.4	32	
AM036NN4DCH/AA	40.8	High	36000	28000	40000	847.7	42	58
		Mid	24100	20400	38300	777.0	39	
		Low	18000	16100	36500	706.4	36	
AM048NN4DCH/AA	40.8	High	48000	37000	54000	1024.3	45	60
		Mid	32400	27500	52000	953.6	42	
		Low	24000	21500	49100	847.7	39	

#### NOTE

- Sound data is based on cooling operation.

#### Electric Characteristics

Indoor Unit	Power Supply (Ø, #, V, Hz)	Power Input (W)	Current Input (A)	MCA (A)	MFA (A)	FLA (A)
AM009NN4DCH/AA	1,2,208-230,60	32	0.25	0.41	15	0.33
AM012NN4DCH/AA		32	0.25	0.41	15	0.33
AM018NN4DCH/AA		32	0.25	0.41	15	0.33
AM024NN4DCH/AA		40	0.3	0.41	15	0.33
AM030NN4DCH/AA		65	0.5	0.49	15	0.39
AM036NN4DCH/AA		75	0.56	0.49	15	0.39
AM048NN4DCH/AA		90	0.75	0.49	15	0.39

#### NOTE

- MCA : Minimum circuit amperes
- MFA : Maximum fuse amperes
- FLA : Full load amperes
- Select wire size based on the value of MCA

# 3. Capacity Table

## Wind-Free 4Way Cassette

Cooling

TC : Total Capacity, SHC : Sensible Heat Capacity

Capacity Index (MBH)	Outdoor Air Temp. (°F, WB)	Indoor temperature (°F, WB)													
		57		61		64		67		70		72		75	
		TC	SHC	TC	SHC	TC	SHC	TC	SHC	TC	SHC	TC	SHC	TC	SHC
		Btu/h	Btu/h	Btu/h	Btu/h	Btu/h	Btu/h	Btu/h	Btu/h	Btu/h	Btu/h	Btu/h	Btu/h	Btu/h	Btu/h
009	50	6,300	5,300	7,400	5,900	8,500	6,500	9,000	6,500	9,300	6,500	10,200	6,500	10,800	6,200
	54	6,300	5,300	7,400	5,900	8,500	6,500	9,000	6,500	9,300	6,500	10,200	6,500	10,800	6,200
	58	6,300	5,300	7,400	5,900	8,500	6,500	9,000	6,500	9,300	6,500	10,000	6,300	10,800	6,200
	60	6,300	5,300	7,400	5,900	8,500	6,500	9,000	6,500	9,300	6,500	10,000	6,300	10,600	6,000
	64	6,300	5,300	7,400	5,900	8,500	6,500	9,000	6,500	9,300	6,500	10,000	6,300	10,600	6,000
	67	6,300	5,300	7,400	5,900	8,500	6,500	9,000	6,500	9,300	6,500	10,000	6,300	10,600	6,000
	70	6,300	5,300	7,400	5,900	8,500	6,500	9,000	6,500	9,300	6,500	10,000	6,300	10,600	6,000
	73	6,300	5,300	7,400	5,900	8,500	6,500	9,000	6,500	9,300	6,500	10,000	6,300	10,600	6,000
	77	6,300	5,300	7,400	5,900	8,500	6,500	9,000	6,500	9,300	6,500	10,000	6,300	10,600	6,000
	80	6,300	5,300	7,400	5,900	8,500	6,500	9,000	6,500	9,300	6,500	10,000	6,300	10,600	6,000
	84	6,300	5,300	7,400	5,900	8,500	6,500	9,000	6,500	9,300	6,500	10,000	6,300	10,600	6,000
	88	6,300	5,300	7,400	5,900	8,500	6,500	9,000	6,500	9,300	6,500	10,000	6,300	10,600	6,000
	92	6,300	5,300	7,400	5,900	8,500	6,500	9,000	6,500	9,300	6,500	10,000	6,300	10,600	6,000
	95	6,300	5,300	7,400	5,900	8,500	6,500	9,000	6,500	9,300	6,500	10,000	6,300	10,600	6,000
	99	6,300	5,300	7,400	5,900	8,500	6,500	9,000	6,500	9,300	6,500	10,000	6,300	10,600	5,900
	103	6,300	5,300	7,400	5,900	8,500	6,500	9,000	6,500	9,300	6,500	10,000	6,300	10,600	5,700
	107	6,300	5,300	7,400	5,900	8,500	6,500	8,700	6,300	9,000	6,300	9,300	6,000	9,700	5,300
111	6,300	5,300	7,400	5,900	8,100	6,300	8,500	6,200	8,700	6,200	8,900	5,900	9,000	5,000	
115	6,300	5,300	7,400	5,900	8,100	6,300	8,500	6,200	8,700	6,200	8,900	5,900	9,000	5,000	
118	6,300	5,300	7,400	5,900	8,100	6,300	8,500	6,200	8,700	6,200	8,900	5,900	9,000	5,000	
012	50	8,300	7,300	9,700	8,300	11,300	9,000	12,000	9,300	12,300	9,300	13,300	9,300	14,300	9,000
	54	8,300	7,300	9,700	8,300	11,300	9,000	12,000	9,300	12,300	9,300	13,300	9,300	14,300	9,000
	58	8,300	7,300	9,700	8,300	11,300	9,000	12,000	9,300	12,300	9,300	13,300	9,300	14,300	9,000
	60	8,300	7,300	9,700	8,300	11,300	9,000	12,000	9,300	12,300	9,300	13,300	9,300	14,300	9,000
	64	8,300	7,300	9,700	8,300	11,300	9,000	12,000	9,300	12,300	9,300	13,300	9,300	14,300	9,000
	67	8,300	7,300	9,700	8,300	11,300	9,000	12,000	9,300	12,300	9,300	13,300	9,300	14,000	8,700
	70	8,300	7,300	9,700	8,300	11,300	9,000	12,000	9,300	12,300	9,300	13,300	9,300	14,000	8,700
	73	8,300	7,300	9,700	8,300	11,300	9,000	12,000	9,300	12,300	9,300	13,300	9,300	14,000	8,700
	77	8,300	7,300	9,700	8,300	11,300	9,000	12,000	9,300	12,300	9,300	13,300	9,300	14,000	8,700
	80	8,300	7,300	9,700	8,300	11,300	9,000	12,000	9,300	12,300	9,300	13,300	9,300	14,000	8,700
	84	8,300	7,300	9,700	8,300	11,300	9,000	12,000	9,300	12,300	9,300	13,300	9,300	14,000	8,700
	88	8,300	7,300	9,700	8,300	11,300	9,000	12,000	9,300	12,300	9,300	13,300	9,300	14,000	8,700
	92	8,300	7,300	9,700	8,300	11,300	9,000	12,000	9,300	12,300	9,300	13,300	9,300	14,000	8,700
	95	8,300	7,300	9,700	8,300	11,300	9,000	12,000	9,300	12,300	9,300	13,300	9,300	14,000	8,700
	99	8,300	7,300	9,700	8,300	11,300	9,000	12,000	9,300	12,300	9,300	13,200	9,000	14,000	8,700
	103	8,300	7,300	9,700	8,300	11,300	9,000	12,000	9,300	12,300	9,300	12,900	9,000	13,700	8,562.5
	107	8,300	7,300	9,700	8,300	11,300	9,000	11,800	9,204	12,000	9,120	12,400	8,700	13,000	8,255
111	8,300	7,300	9,700	8,300	11,000	8,800	11,500	8,970	11,700	9,009	12,000	8,520	12,400	7,998	
115	8,300	7,300	9,700	8,300	10,800	8,700	11,300	8,927	11,500	8,855	11,700	8,424	12,000	7,860	
118	8,300	7,300	9,700	8,300	10,700	8,667	11,100	8,880	11,300	8,814	11,400	8,322	11,800	7,788	



# 3. Capacity Table

## Wind-Free 4Way Cassette

Capacity Index (MBH)	Outdoor Air Temp. (°F, WB)	Indoor temperature (°F, WB)													
		57		61		64		67		70		72		75	
		TC	SHC	TC	SHC	TC	SHC	TC	SHC	TC	SHC	TC	SHC	TC	SHC
		Btu/h	Btu/h	Btu/h	Btu/h	Btu/h	Btu/h	Btu/h	Btu/h	Btu/h	Btu/h	Btu/h	Btu/h	Btu/h	Btu/h
018	50	12,500	10,300	14,800	11,300	17,000	12,500	18,000	12,500	18,600	12,500	20,300	12,500	21,500	11,900
	54	12,500	10,300	14,800	11,300	17,000	12,500	18,000	12,500	18,600	12,500	20,300	12,500	21,500	11,900
	58	12,500	10,300	14,800	11,300	17,000	12,500	18,000	12,500	18,600	12,500	19,900	12,200	21,500	11,900
	60	12,500	10,300	14,800	11,300	17,000	12,500	18,000	12,500	18,600	12,500	19,900	12,200	21,200	11,600
	64	12,500	10,300	14,800	11,300	17,000	12,500	18,000	12,500	18,600	12,500	19,900	12,200	21,200	11,600
	67	12,500	10,300	14,800	11,300	17,000	12,500	18,000	12,500	18,600	12,500	19,900	12,200	21,200	11,600
	70	12,500	10,300	14,800	11,300	17,000	12,500	18,000	12,500	18,600	12,500	19,900	12,200	21,200	11,600
	73	12,500	10,300	14,800	11,300	17,000	12,500	18,000	12,500	18,600	12,500	19,900	12,200	21,200	11,600
	77	12,500	10,300	14,800	11,300	17,000	12,500	18,000	12,500	18,600	12,500	19,900	12,200	21,200	11,600
	80	12,500	10,300	14,800	11,300	17,000	12,500	18,000	12,500	18,600	12,500	19,900	12,200	21,200	11,600
	84	12,500	10,300	14,800	11,300	17,000	12,500	18,000	12,500	18,600	12,500	19,900	12,200	21,200	11,600
	88	12,500	10,300	14,800	11,300	17,000	12,500	18,000	12,500	18,600	12,500	19,900	12,200	21,200	11,600
	92	12,500	10,300	14,800	11,300	17,000	12,500	18,000	12,500	18,600	12,500	19,900	12,200	21,200	11,600
	95	12,500	10,300	14,800	11,300	17,000	12,500	18,000	12,500	18,600	12,500	19,900	12,200	21,200	11,600
	99	12,500	10,300	14,800	11,300	17,000	12,500	18,000	12,500	18,600	12,500	19,900	12,200	21,200	11,300
103	12,500	10,300	14,800	11,300	17,000	12,500	18,000	12,500	18,600	12,500	19,900	12,200	21,200	10,900	
107	12,500	10,300	14,800	11,300	17,000	12,500	17,400	12,200	18,000	12,200	18,600	11,600	19,300	10,300	
111	12,500	10,300	14,800	11,300	16,100	12,200	17,000	11,900	17,400	11,900	17,700	11,300	18,000	9,600	
115	12,500	10,300	14,800	11,300	16,100	12,200	17,000	11,900	17,400	11,900	17,700	11,300	18,000	9,600	
118	12,500	10,300	14,800	11,300	16,100	12,200	17,000	11,900	17,400	11,900	17,700	11,300	18,000	9,600	
024	50	16,600	13,500	19,600	15,200	22,600	16,200	24,000	16,900	25,000	16,900	27,000	17,200	28,700	16,200
	54	16,600	13,500	19,600	15,200	22,600	16,200	24,000	16,900	25,000	16,900	26,700	16,900	28,700	16,200
	58	16,600	13,500	19,600	15,200	22,600	16,200	24,000	16,900	25,000	16,900	26,700	16,900	28,700	16,200
	60	16,600	13,500	19,600	15,200	22,600	16,200	24,000	16,900	25,000	16,900	26,700	16,900	28,400	16,200
	64	16,600	13,500	19,600	15,200	22,600	16,200	24,000	16,900	25,000	16,900	26,700	16,900	28,400	16,200
	67	16,600	13,500	19,600	15,200	22,600	16,200	24,000	16,900	25,000	16,900	26,700	16,900	28,400	16,200
	70	16,600	13,500	19,600	15,200	22,600	16,200	24,000	16,900	25,000	16,900	26,700	16,900	28,400	16,200
	73	16,600	13,500	19,600	15,200	22,600	16,200	24,000	16,900	25,000	16,900	26,700	16,900	28,400	16,200
	77	16,600	13,500	19,600	15,200	22,600	16,200	24,000	16,900	25,000	16,900	26,700	16,900	28,400	16,200
	80	16,600	13,500	19,600	15,200	22,600	16,200	24,000	16,900	25,000	16,900	26,700	16,900	28,400	16,200
	84	16,600	13,500	19,600	15,200	22,600	16,200	24,000	16,900	25,000	16,900	26,700	16,900	28,400	16,200
	88	16,600	13,500	19,600	15,200	22,600	16,200	24,000	16,900	25,000	16,900	26,700	16,900	28,400	16,200
	92	16,600	13,500	19,600	15,200	22,600	16,200	24,000	16,900	25,000	16,900	26,700	16,900	28,400	16,200
	95	16,600	13,500	19,600	15,200	22,600	16,200	24,000	16,900	25,000	16,900	26,700	16,900	28,400	16,200
	99	16,600	13,500	19,600	15,200	22,600	16,200	24,000	16,900	24,700	16,600	26,400	16,600	27,700	15,900
103	16,600	13,500	19,600	15,200	22,600	16,200	24,000	16,900	24,700	16,600	26,000	16,200	27,400	15,500	
107	16,600	13,500	19,600	15,200	22,600	16,200	23,300	16,200	23,700	15,900	24,700	15,500	25,700	14,900	
111	16,600	13,500	19,600	15,200	21,300	15,500	22,600	15,200	23,000	15,500	23,700	15,200	24,000	14,200	
115	16,600	13,500	19,600	15,200	21,300	15,500	22,600	15,200	23,000	15,500	23,700	15,200	24,000	14,200	
118	16,600	13,500	19,600	15,200	21,300	15,500	22,600	15,200	23,000	15,500	23,700	15,200	24,000	14,200	

# 3. Capacity Table

## Wind-Free 4Way Cassette

Capacity Index (MBH)	Outdoor Air Temp. (°F, WB)	Indoor temperature (°F, WB)													
		57		61		64		67		70		72		75	
		TC	SHC	TC	SHC	TC	SHC	TC	SHC	TC	SHC	TC	SHC	TC	SHC
		Btu/h	Btu/h	Btu/h	Btu/h	Btu/h	Btu/h	Btu/h	Btu/h	Btu/h	Btu/h	Btu/h	Btu/h	Btu/h	Btu/h
030	50	20,700	17,300	24,300	19,000	28,000	21,000	30,000	21,000	31,300	21,000	33,700	21,000	36,000	21,000
	54	20,700	17,300	24,300	19,000	28,000	21,000	30,000	21,000	31,300	21,000	33,700	21,000	36,000	21,000
	58	20,700	17,300	24,300	19,000	28,000	21,000	30,000	21,000	31,000	21,000	33,300	20,700	35,700	20,700
	60	20,700	17,300	24,300	19,000	28,000	21,000	30,000	21,000	31,000	21,000	33,300	20,700	35,700	20,700
	64	20,700	17,300	24,300	19,000	28,000	21,000	30,000	21,000	31,000	21,000	33,300	20,700	35,300	20,300
	67	20,700	17,300	24,300	19,000	28,000	21,000	30,000	21,000	31,000	21,000	33,300	20,700	35,300	20,300
	70	20,700	17,300	24,300	19,000	28,000	21,000	30,000	21,000	31,000	21,000	33,300	20,700	35,300	20,300
	73	20,700	17,300	24,300	19,000	28,000	21,000	30,000	21,000	31,000	21,000	33,300	20,700	35,300	20,300
	77	20,700	17,300	24,300	19,000	28,000	21,000	30,000	21,000	31,000	21,000	33,300	20,700	35,300	20,300
	80	20,700	17,300	24,300	19,000	28,000	21,000	30,000	21,000	31,000	21,000	33,300	20,700	35,300	20,300
	84	20,700	17,300	24,300	19,000	28,000	21,000	30,000	21,000	31,000	21,000	33,300	20,700	35,300	20,300
	88	20,700	17,300	24,300	19,000	28,000	21,000	30,000	21,000	31,000	21,000	33,300	20,700	35,300	20,300
	92	20,700	17,300	24,300	19,000	28,000	21,000	30,000	21,000	31,000	21,000	33,300	20,700	35,300	20,300
	95	20,700	17,300	24,300	19,000	28,000	21,000	30,000	21,000	31,000	21,000	33,300	20,700	35,300	20,300
	99	20,700	17,300	24,300	19,000	28,000	21,000	30,000	21,000	31,000	21,000	33,000	20,300	34,700	20,000
	103	20,700	17,300	24,300	19,000	28,000	21,000	30,000	21,300	30,700	20,700	32,300	20,000	34,000	19,700
107	20,700	17,300	24,300	19,000	28,000	21,000	29,000	20,700	29,700	20,700	31,000	19,300	32,000	19,300	
111	20,700	17,300	24,300	19,000	26,700	20,300	28,700	20,300	28,700	20,300	29,300	18,700	30,000	18,300	
115	20,700	17,300	24,300	19,000	26,700	20,300	28,700	20,300	28,700	20,300	29,300	18,700	30,000	18,300	
118	20,700	17,300	24,300	19,000	26,700	20,300	28,700	20,300	28,700	20,300	29,300	18,700	30,000	18,300	
036	50	24,800	20,600	29,300	22,800	33,800	25,100	36,000	25,400	37,300	25,400	40,200	25,400	43,100	25,400
	54	24,800	20,600	29,300	22,800	33,800	25,100	36,000	25,400	37,300	25,400	40,200	25,400	43,100	25,400
	58	24,800	20,600	29,300	22,800	33,800	25,100	36,000	25,400	37,300	25,400	40,200	25,400	42,800	25,100
	60	24,800	20,600	29,300	22,800	33,800	25,100	36,000	25,400	37,300	25,400	40,200	25,400	42,800	25,100
	64	24,800	20,600	29,300	22,800	33,800	25,100	36,000	25,400	37,300	25,400	39,900	25,400	42,400	24,800
	67	24,800	20,600	29,300	22,800	33,800	25,100	36,000	25,400	37,300	25,400	39,900	25,400	42,400	24,800
	70	24,800	20,600	29,300	22,800	33,800	25,100	36,000	25,400	37,300	25,400	39,900	25,400	42,400	24,800
	73	24,800	20,600	29,300	22,800	33,800	25,100	36,000	25,400	37,300	25,400	39,900	25,400	42,400	24,800
	77	24,800	20,600	29,300	22,800	33,800	25,100	36,000	25,400	37,300	25,400	39,900	25,400	42,400	24,800
	80	24,800	20,600	29,300	22,800	33,800	25,100	36,000	25,400	37,300	25,400	39,900	25,400	42,400	24,800
	84	24,800	20,600	29,300	22,800	33,800	25,100	36,000	25,400	37,300	25,400	39,900	25,400	42,400	24,800
	88	24,800	20,600	29,300	22,800	33,800	25,100	36,000	25,400	37,300	25,400	39,900	25,400	42,400	24,800
	92	24,800	20,300	29,300	22,500	33,800	25,100	36,000	25,400	37,300	25,400	39,900	25,400	42,400	24,800
	95	24,800	20,300	29,300	22,500	33,800	25,100	36,000	25,400	37,300	25,400	39,900	25,400	42,400	24,800
	99	24,800	20,300	29,300	22,500	33,800	25,100	36,000	25,400	37,300	25,400	39,500	25,100	41,800	24,400
	103	24,800	20,300	29,300	22,500	33,800	25,100	36,000	25,700	37,000	25,100	38,900	24,800	40,800	24,100
107	24,800	20,300	29,300	22,500	33,800	25,100	35,000	24,800	35,700	24,400	37,300	24,100	38,600	23,800	
111	24,800	20,300	29,300	22,500	32,100	23,800	34,100	24,400	34,700	24,100	35,400	23,100	36,000	22,500	
115	24,800	20,300	29,300	22,500	32,100	23,800	34,100	24,400	34,700	24,100	35,400	23,100	36,000	22,500	
118	24,800	20,300	29,300	22,500	32,100	23,800	34,100	24,400	34,700	24,100	35,400	23,100	36,000	22,500	

# 3. Capacity Table

## Wind-Free 4Way Cassette

Capacity Index (MBH)	Outdoor Air Temp. (°F, WB)	Indoor temperature (°F, WB)													
		57		61		64		67		70		72		75	
		TC	SHC	TC	SHC	TC	SHC	TC	SHC	TC	SHC	TC	SHC	TC	SHC
		Btu/h	Btu/h	Btu/h	Btu/h	Btu/h	Btu/h	Btu/h	Btu/h	Btu/h	Btu/h	Btu/h	Btu/h	Btu/h	Btu/h
048	50	33,300	26,400	39,100	29,100	44,900	32,200	48,000	32,900	50,100	32,900	53,800	32,600	57,600	33,300
	54	33,300	26,400	39,100	29,100	44,900	32,200	48,000	32,900	49,700	32,900	53,500	32,900	57,300	32,900
	58	33,300	26,400	39,100	29,100	44,900	32,200	48,000	32,900	49,700	32,900	53,500	32,900	57,300	32,900
	60	33,300	26,400	39,100	29,100	44,900	32,200	48,000	32,900	49,700	32,900	53,500	32,900	56,900	32,600
	64	33,300	26,400	39,100	29,100	44,900	32,200	48,000	32,900	49,700	32,900	53,100	32,600	56,900	32,600
	67	33,300	26,400	39,100	29,100	44,900	32,200	48,000	32,900	49,700	32,900	53,100	32,600	56,600	32,200
	70	33,300	26,400	39,100	29,100	44,900	32,200	48,000	32,900	49,700	32,900	53,100	32,600	56,600	32,200
	73	33,300	26,400	39,100	29,100	44,900	32,200	48,000	32,900	49,700	32,900	53,100	32,600	56,600	32,200
	77	33,300	26,400	39,100	29,100	44,900	32,200	48,000	32,900	49,700	32,900	53,100	32,600	56,600	32,200
	80	33,300	26,400	39,100	29,100	44,900	32,200	48,000	32,900	49,700	32,900	53,100	32,600	56,600	32,200
	84	33,300	26,400	39,100	29,100	44,900	32,200	48,000	32,900	49,700	32,900	53,100	32,600	56,600	32,200
	88	33,300	26,400	39,100	29,100	44,900	32,200	48,000	32,900	49,700	32,900	53,100	32,600	56,600	32,200
	92	33,300	26,400	39,100	29,100	44,900	32,200	48,000	32,900	49,700	32,900	53,100	32,600	56,600	32,200
	95	33,300	26,400	39,100	29,100	44,900	32,200	48,000	32,900	49,700	32,900	53,100	32,600	56,600	32,200
	99	33,300	26,400	39,100	29,100	44,900	32,200	48,000	32,900	49,700	32,900	52,800	32,200	55,900	31,500
103	33,300	26,400	39,100	29,100	44,900	32,200	48,000	32,900	49,400	32,200	51,800	31,900	54,500	30,900	
107	33,300	26,400	39,100	29,100	44,900	32,200	46,600	31,900	47,700	31,500	49,400	30,500	51,400	29,100	
111	33,300	26,400	39,100	29,100	42,900	31,200	45,600	31,500	45,900	30,200	47,000	28,800	48,000	27,800	
115	33,300	26,400	39,100	29,100	42,900	31,200	45,600	31,500	45,900	30,200	47,000	28,800	48,000	27,800	
118	33,300	26,400	39,100	29,100	42,900	31,200	45,600	31,500	45,900	30,200	47,000	28,800	48,000	27,800	

**NOTE**

- The performance table shows the average value of each conditions.

# 3. Capacity Table

## Wind-Free 4Way Cassette

Heating

TC : Total Capacity (kW)

Capacity Index	Outdoor Air Temp. (°F)		Indoor temperature (°F, WB)				
			61	65	70	72	75
	DB	WB	TC Btu/h	TC Btu/h	TC Btu/h	TC Btu/h	TC Btu/h
009	-3.6	-4	6,450	6,300	6,200	6,100	6,100
	-1.8	-2	6,550	6,450	6,300	6,200	6,200
	2	1	6,600	6,600	6,350	6,300	6,300
	6	5	6,950	6,800	6,550	6,450	6,300
	10	9	7,250	7,100	6,950	6,950	6,800
	13	12	7,600	7,600	7,350	7,250	7,250
	17	15	7,850	7,750	7,600	7,500	7,350
	19	18	8,100	7,950	7,850	7,750	7,450
	23	21	8,600	8,450	8,200	8,100	7,750
	26	24	8,950	8,750	8,600	8,450	8,100
	30	28	9,150	9,000	8,750	8,600	8,200
	35	32	9,400	9,250	8,950	8,750	8,250
	39	36	9,750	9,750	9,400	9,250	8,750
	44	40	10,250	10,100	9,650	9,400	8,750
	47	43	10,750	10,600	10,000	9,600	8,750
	51	47	11,050	10,750	10,000	9,600	8,750
54	50	11,400	10,900	10,000	9,600	8,750	
57	53	11,750	11,050	10,000	9,600	8,750	
60	56	12,050	11,250	10,000	9,600	8,750	
012	-3.6	-4	8,400	8,300	8,100	8,100	8,100
	-1.8	-2	8,800	8,500	8,200	8,200	8,100
	2	1	9,100	8,800	8,400	8,400	8,100
	6	5	9,500	9,100	8,800	8,800	8,400
	10	9	9,800	9,500	9,300	9,100	9,000
	13	12	10,200	10,100	10,000	9,800	9,600
	17	15	10,500	10,400	10,300	10,200	10,000
	19	18	10,900	10,700	10,500	10,500	10,200
	23	21	11,600	11,200	11,000	10,900	10,500
	26	24	11,900	11,700	11,400	11,200	10,900
	30	28	12,300	12,100	11,700	11,600	11,000
	35	32	12,600	12,500	12,100	11,900	11,400
	39	36	13,300	13,000	12,600	12,300	11,900
	44	40	13,800	13,600	13,000	12,600	11,900
	47	43	14,400	14,100	13,500	13,000	11,900
	51	47	14,800	14,400	13,500	13,000	11,900
54	50	15,400	14,700	13,500	13,000	11,900	
57	53	15,800	14,900	13,500	13,000	11,900	
60	56	16,100	15,000	13,500	13,000	11,900	

# 3. Capacity Table

## Wind-Free 4Way Cassette

Capacity Index	Outdoor Air Temp. (°F)		Indoor temperature (°F, WB)				
			61	65	70	72	75
	DB	WB	TC Btu/h	TC Btu/h	TC Btu/h	TC Btu/h	TC Btu/h
018	-3.6	-4	12,900	12,600	12,400	12,200	12,200
	-1.8	-2	13,100	12,900	12,600	12,400	12,400
	2	1	13,200	13,200	12,700	12,600	12,600
	6	5	13,900	13,600	13,100	12,900	12,600
	10	9	14,500	14,200	13,900	13,900	13,600
	13	12	15,200	15,200	14,700	14,500	14,500
	17	15	15,700	15,500	15,200	15,000	14,700
	19	18	16,200	15,900	15,700	15,500	14,900
	23	21	17,200	16,900	16,400	16,200	15,500
	26	24	17,900	17,500	17,200	16,900	16,200
	30	28	18,300	18,000	17,500	17,200	16,400
	35	32	18,800	18,500	17,900	17,500	16,500
	39	36	19,500	19,500	18,800	18,500	17,500
	44	40	20,500	20,200	19,300	18,800	17,500
	47	43	21,500	21,200	20,000	19,200	17,500
51	47	22,100	21,500	20,000	19,200	17,500	
54	50	22,800	21,800	20,000	19,200	17,500	
57	53	23,500	22,100	20,000	19,200	17,500	
60	56	24,100	22,500	20,000	19,200	17,500	
024	-3.6	-4	17,200	17,200	16,700	16,500	16,500
	-1.8	-2	17,500	17,400	16,800	16,700	16,700
	2	1	17,900	17,500	17,000	16,800	16,800
	6	5	18,600	18,200	17,500	17,200	16,800
	10	9	19,600	19,300	18,800	18,600	18,200
	13	12	20,700	20,300	19,800	19,600	19,600
	17	15	21,200	20,900	20,300	20,200	20,000
	19	18	21,700	21,400	20,900	20,700	20,300
	23	21	22,800	22,800	22,100	21,700	21,000
	26	24	24,200	23,800	23,000	22,400	21,700
	30	28	24,700	24,400	23,500	23,000	22,100
	35	32	25,200	24,900	24,000	23,500	22,400
	39	36	26,600	26,300	25,200	24,900	23,800
	44	40	27,700	27,400	26,100	25,200	23,800
	47	43	28,800	28,400	27,000	25,900	23,800
51	47	29,800	28,800	27,000	25,900	23,800	
54	50	30,500	29,500	27,000	25,900	23,800	
57	53	31,600	29,800	27,000	25,900	23,800	
60	56	32,300	30,200	27,000	25,900	23,800	
030	-3.6	-4	21,300	21,300	20,700	20,500	20,500
	-1.8	-2	21,800	21,800	21,100	20,900	20,700
	2	1	22,300	22,300	21,400	21,300	20,900
	6	5	23,700	23,000	22,000	21,600	21,300
	10	9	24,800	24,400	23,600	23,400	23,000
	13	12	25,900	25,500	25,000	24,800	24,800
	17	15	26,700	26,400	25,800	25,500	25,100
	19	18	27,600	27,300	26,600	26,200	25,500
	23	21	29,000	28,700	27,800	27,300	26,600
	26	24	30,500	30,100	29,200	28,700	27,300
	30	28	31,200	30,800	29,800	29,200	27,800
	35	32	31,900	31,500	30,500	29,800	28,300
	39	36	33,300	32,900	31,900	31,200	29,800
	44	40	35,100	34,400	32,900	31,900	29,800
	47	43	36,500	35,800	34,000	32,600	29,800
51	47	37,500	36,500	34,000	32,600	29,800	
54	50	38,600	37,200	34,000	32,600	29,800	
57	53	39,700	37,500	34,000	32,600	29,800	
60	56	41,100	38,300	34,000	32,600	29,800	

# 3. Capacity Table

## Wind-Free 4Way Cassette

Capacity Index	Outdoor Air Temp. (°F)		Indoor temperature (°F, WB)				
			61	65	70	72	75
	DB	WB	TC	TC	TC	TC	TC
036	-3.6	-4	24,700	24,700	24,300	24,300	24,300
	-1.8	-2	25,700	25,300	24,800	24,700	24,500
	2	1	26,700	26,000	25,200	25,000	24,700
	6	5	28,000	27,000	26,000	25,700	25,000
	10	9	29,300	28,700	27,700	27,300	27,000
	13	12	30,700	30,000	29,500	29,300	29,000
	17	15	31,500	31,000	30,300	30,000	29,500
	19	18	32,300	32,000	31,000	30,700	30,000
	23	21	34,000	33,700	32,500	32,000	31,000
	26	24	35,700	35,300	34,300	33,700	32,300
	30	28	36,700	36,200	35,200	34,300	32,800
	35	32	37,700	37,000	36,000	35,000	33,300
	39	36	39,300	38,700	37,500	36,700	35,300
	44	40	41,000	40,700	38,800	37,700	35,300
	47	43	43,000	42,300	40,000	38,300	35,300
	51	47	44,300	43,000	40,000	38,300	35,300
54	50	45,700	43,700	40,000	38,300	35,300	
57	53	46,700	44,300	40,000	38,300	35,300	
60	56	48,000	45,000	40,000	38,300	35,300	
048	-3.6	-4	33,300	33,300	33,000	33,000	32,600
	-1.8	-2	34,400	34,000	33,300	33,300	32,800
	2	1	35,400	34,700	33,700	33,700	33,000
	6	5	37,500	36,500	34,900	34,400	33,300
	10	9	39,300	38,600	37,500	37,200	36,100
	13	12	41,000	40,700	39,800	39,600	38,900
	17	15	42,300	41,700	40,900	40,500	39,600
	19	18	43,500	42,800	41,900	41,400	40,300
	23	21	45,900	45,200	43,800	43,100	42,100
	26	24	48,400	47,700	46,100	45,200	43,500
	30	28	49,400	48,700	47,100	46,100	44,200
	35	32	50,500	49,800	48,000	47,000	44,900
	39	36	52,900	52,200	50,500	49,400	47,300
	44	40	55,400	54,700	52,100	50,500	47,300
	47	43	57,900	56,800	54,000	51,900	47,300
	51	47	59,600	57,900	54,000	51,900	47,300
54	50	61,400	58,600	54,000	51,900	47,300	
57	53	63,100	59,600	54,000	51,900	47,300	
60	56	64,900	60,300	54,000	51,900	47,300	

**NOTE**

- The performance table shows the average value of each conditions.



# 4. Dimensional Drawing

## Wind-Free 4Way Cassette

AM009/012/018/024NN4DCH/AA

Units : mm [inches]

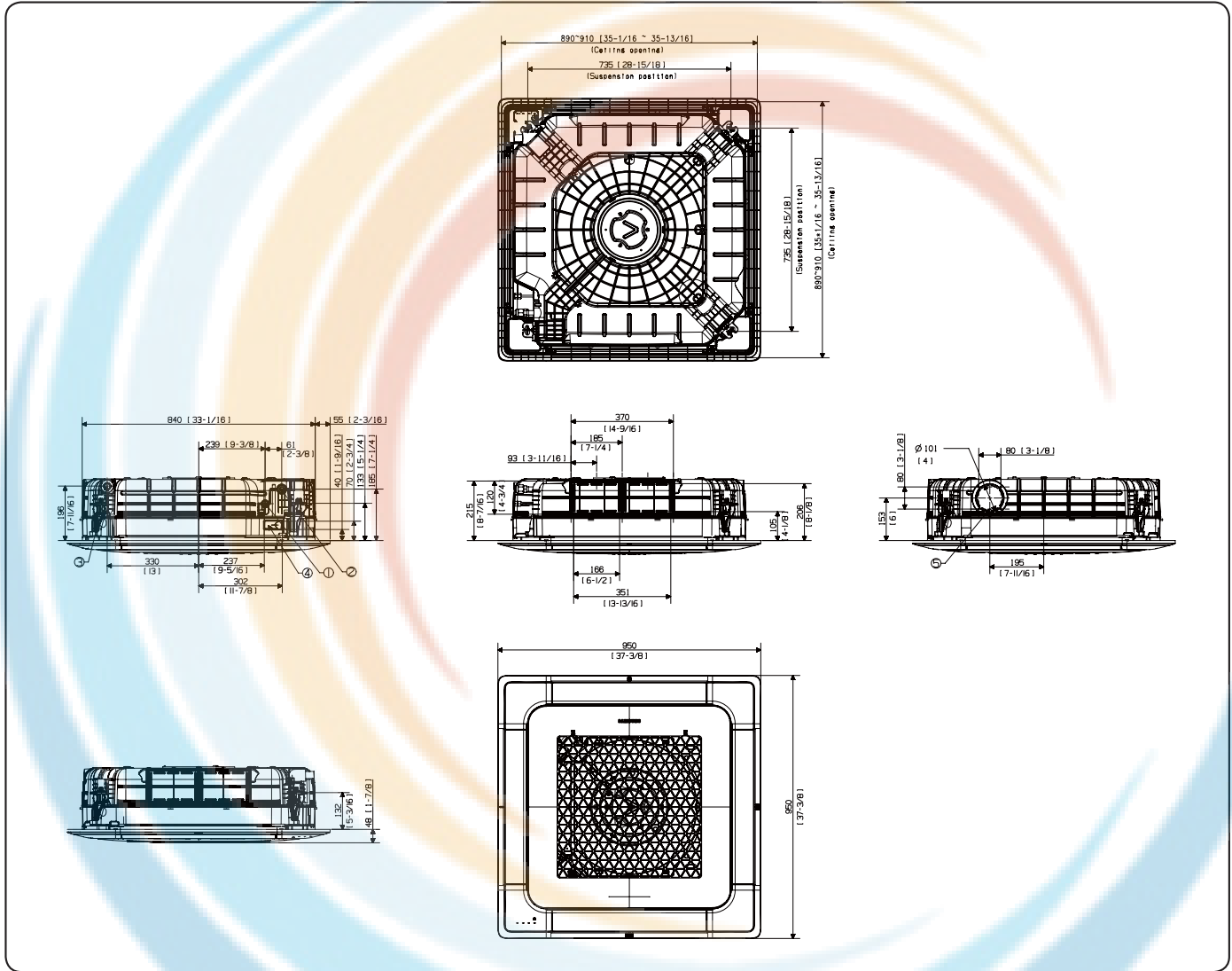

No.	Name	Description	
		AM009/012/018NN4DCH*	AM024NN4DCH*
1	Liquid pipe connection	Φ6.35(1/4)	Φ9.52(3/8)
2	Gas pipe connection	Φ12.7(1/2)	Φ15.88(5/8)
3	Drain pipe connection	VP-25(OD32, ID25)	
4	Power supply & Communication wiring conduit	-	
5	Fresh air intake knockout hole	Φ10[4] , Use M4 Screw	

### NOTE

- As for suspension bolt, please use M8 ~ M10. (Procured at local site)

# 4. Dimensional Drawing

## Wind-Free 4Way Cassette

AM030/036/048NN4DCH/AA

Units : mm [inches]

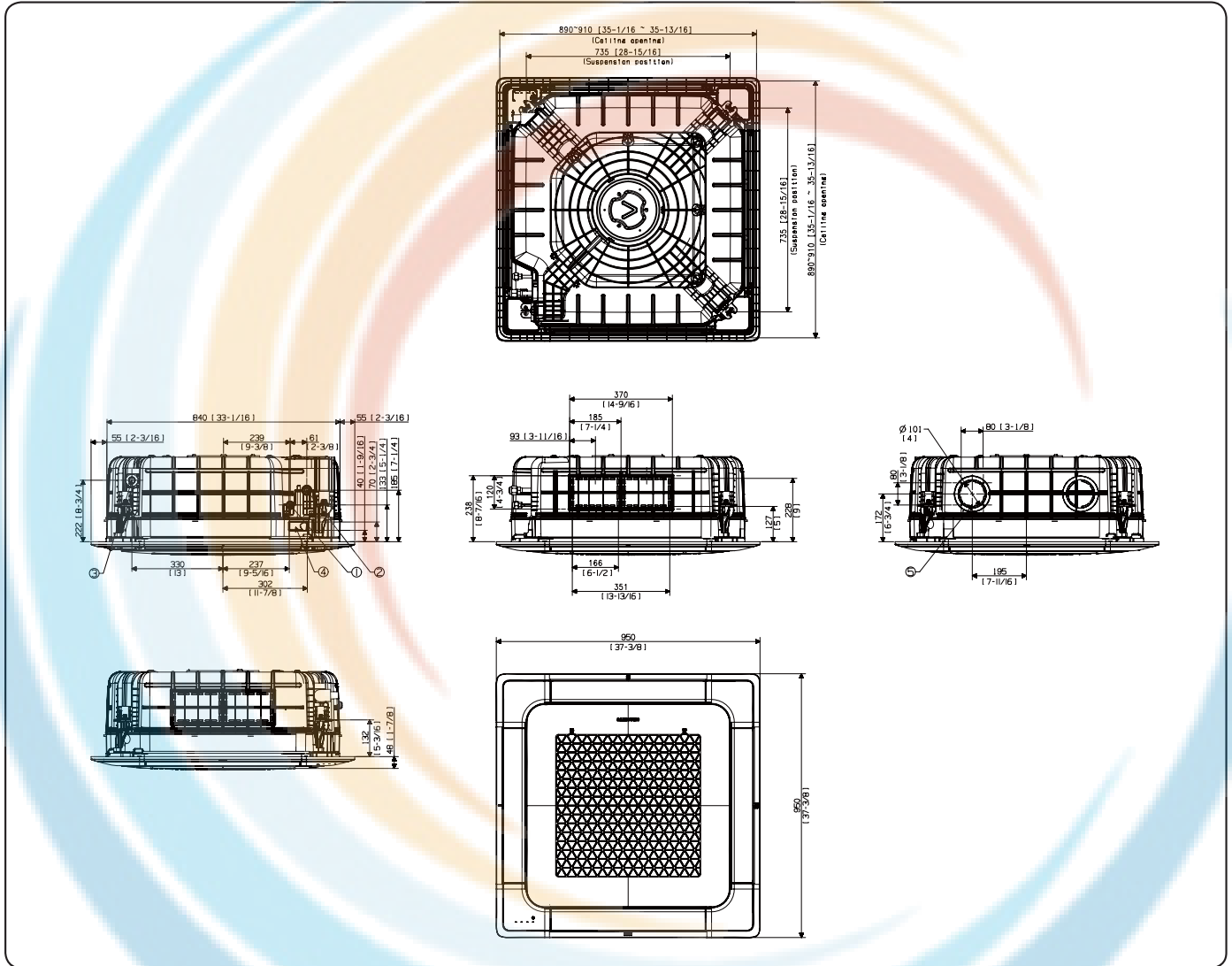

No.	Name	Description
1	Liquid pipe connection	Φ9.52(3/8)
2	Gas pipe connection	Φ15.88(5/8)
3	Drain pipe connection	VP-25(OD32, ID25)
4	Power supply & Communication wiring conduit	-
5	Fresh air intake knockout hole	Φ10[4] , Use M4 Screw

### NOTE

- As for suspension bolt, please use M8 ~ M10. (Procured at local site)

# 5. Center of Gravity

## Wind-Free 4Way Cassette

Units : mm [inches]

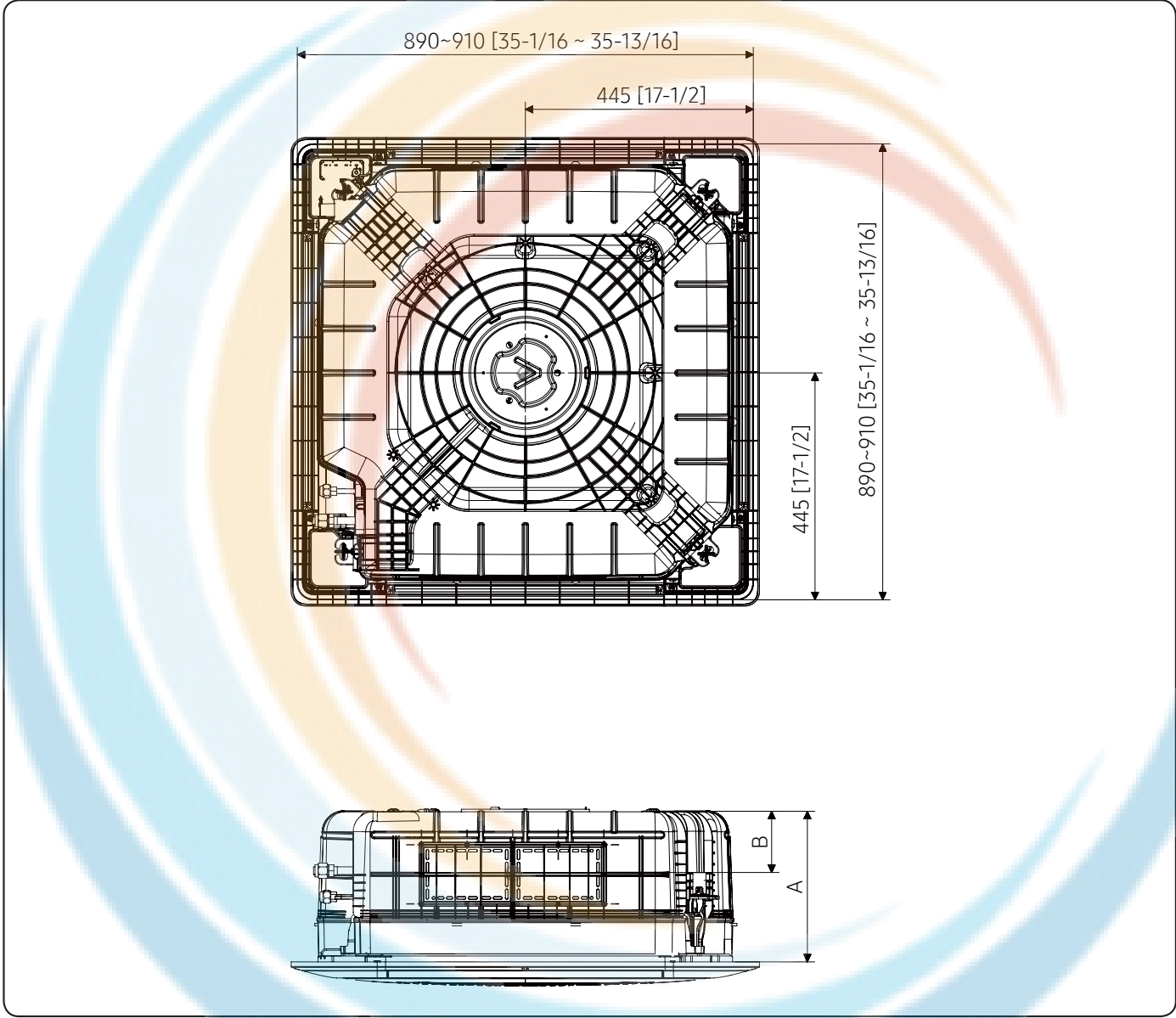

	A	B
AM009/012/018/024NN4DCH/AA	221 [8-11/16]	70 [2-3/4]
AM030/036/048NN4DCH/AA	305 [12]	130 [5-1/8]

# 6. Electrical Wiring Diagram

## Wind-Free 4Way Cassette

AM009 ~ 048NN4DCH/AA

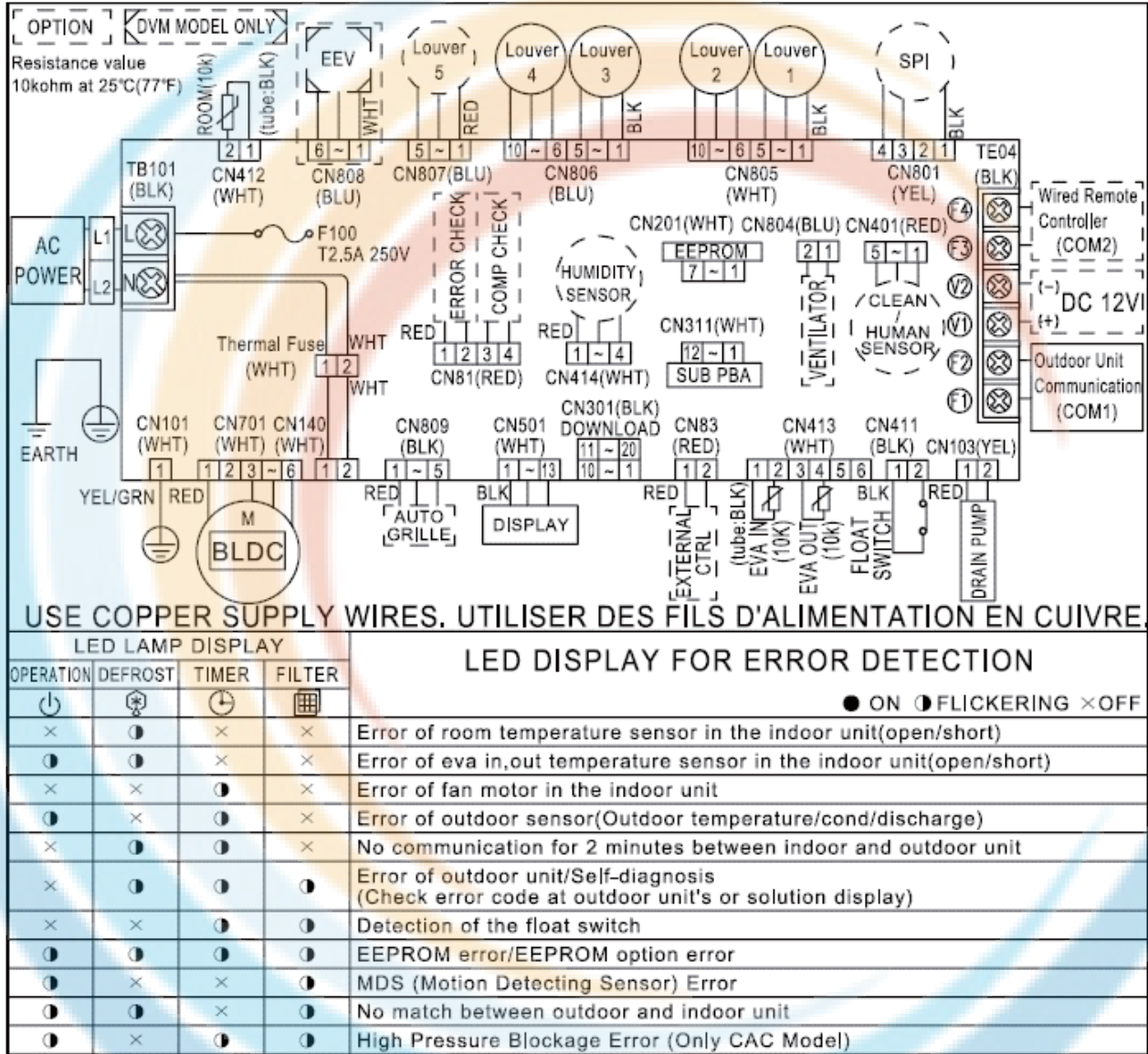

F100	FUSE	SPI	S-Plasma ion	ROOM(10K)	Thermistor ROOM OUT(10K)
M-BLDC	BLDC Motor	EEV	Electronic Expansion Valve	EVA-IN(10K)	Thermistor EVA IN(10K)
		EXT_CONTROL	EXTERNAL_CONTROL	EVA-OUT(10K)	Thermistor EVA OUT(10K)

### NOTE

- This wiring diagram applies only to the Indoor unit.
- Symbols show as follow :  
blk: black, red: red, blu: blue, wht: white, yel: yellow, brn: brown, sky: skyblue: grn: green
- For connection wiring indoor-outdoor transmission F1-F2, indoor-wired remote controller transmission F3-F4.
- ⚡ Protective earth(screw), □□□: connector,  $\frac{N}{\text{---}}$ : The wire quantity

# 7. Sound Data

## Wind-Free 4Way Cassette

### Sound Pressure level

Unit: dB(A)

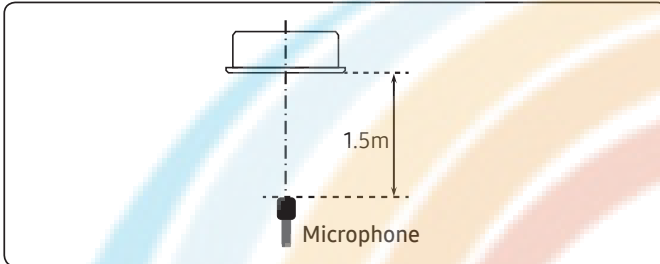

Model	High	MID	LOW
AM009NN4DCH/AA	32	30	28
AM012NN4DCH/AA	32	30	28
AM018NN4DCH/AA	32	30	28
AM024NN4DCH/AA	35	32	28

- NC Curve

1) AM009NN4DCH/AA

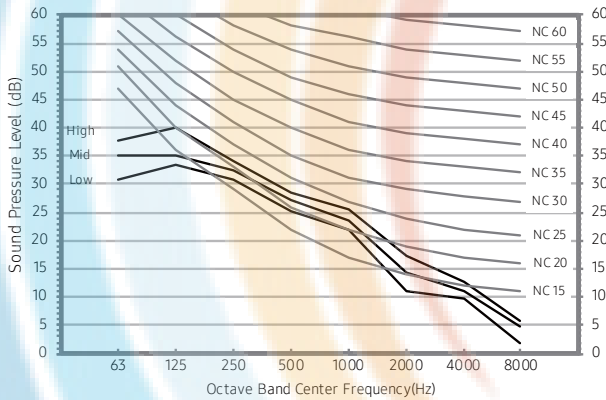

2) AM012NN4DCH/AA

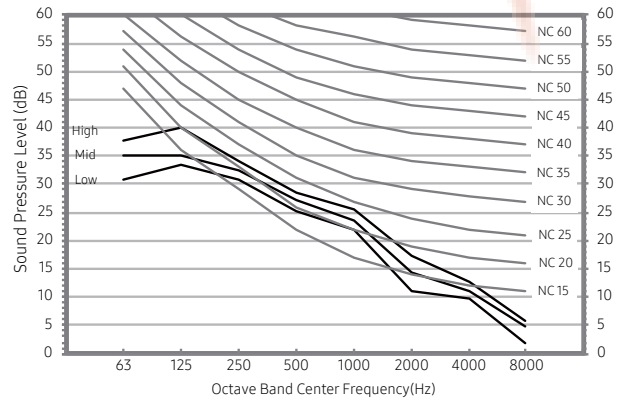

3) AM018NN4DCH/AA

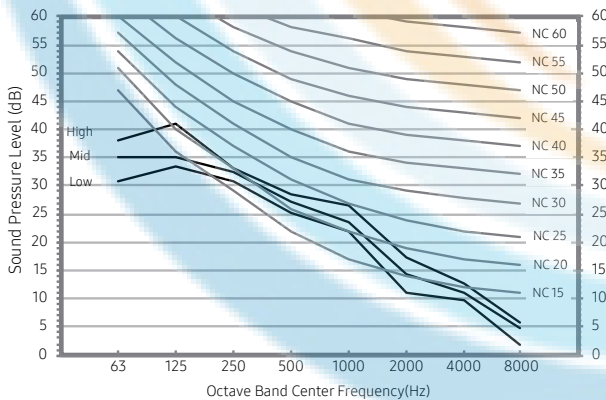

4) AM024NN4DCH/AA

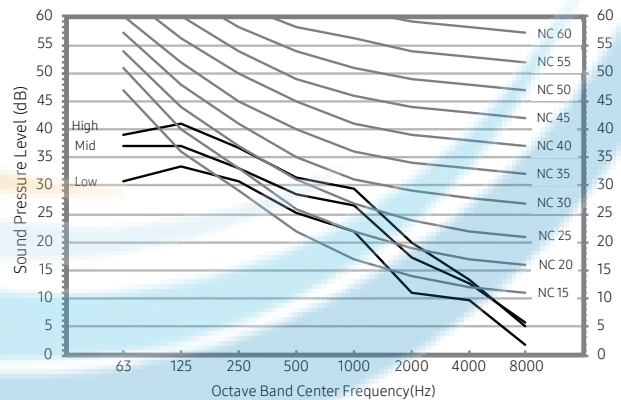

### NOTE

- Specifications may be subject to change without prior notice.
  - Sound pressure level is obtained in an anechoic room.
  - Sound pressure level is a relative value, depending on the distance and acoustic environment.
  - Sound pressure level may differ depending on operation condition.
  - dB(A) = A weighted sound pressure level
  - Reference acoustic pressure 0 dB = 20μPa

# 7. Sound Data

## Wind-Free 4Way Cassette

### Sound Pressure level

Unit: dB(A)

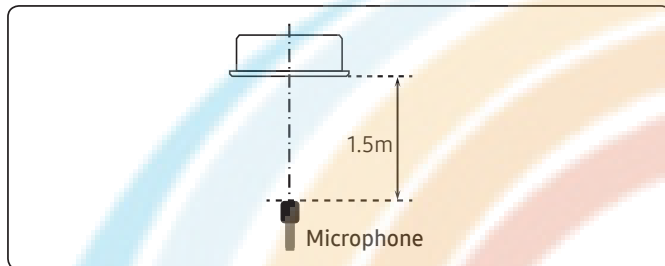

Model	High	MID	LOW
AM030NN4DCH/AA	41	37	32
AM036NN4DCH/AA	42	39	36
AM048NN4DCH/AA	45	42	39

- NC Curve

5) AM030NN4DCH/AA

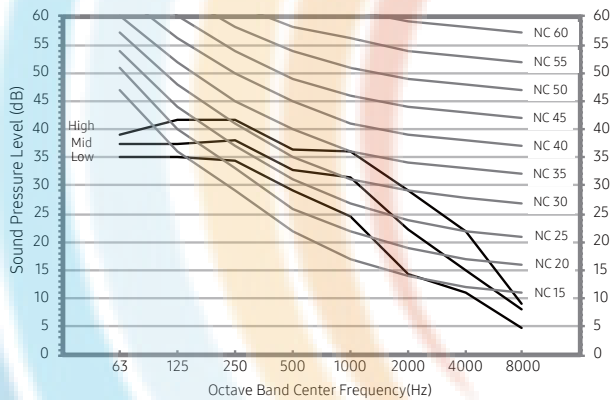

6) AM036NN4DCH/AA

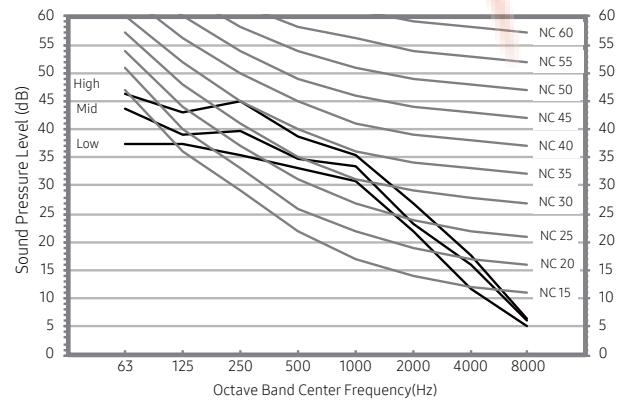

7) AM048NN4DCH/AA

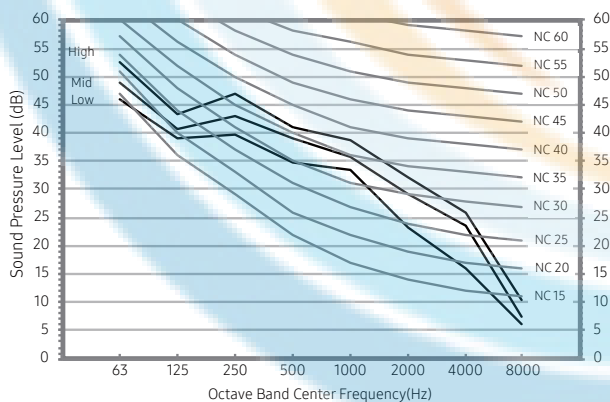

### NOTE

- Specifications may be subject to change without prior notice.
  - Sound pressure level is obtained in an anechoic room.
  - Sound pressure level is a relative value, depending on the distance and acoustic environment.
  - Sound pressure level may differ depending on operation condition.
  - dBA = A weighted sound pressure level
  - Reference acoustic pressure 0 dB = 20μPa



# 7. Sound Data

## Wind-Free 4Way Cassette

### Sound Power level

**NOTE**

Unit: dB(A)

- Specifications may be subject to change without prior notice
  - Sound power level is an absolute value that a sound source generates.
  - dBA = A-weighted sound power level.
  - Reference power : 1pW.
  - Measured according to ISO 3741.

Model	Power
AM009NN4DCH/AA	49
AM012NN4DCH/AA	49
AM018NN4DCH/AA	49
AM024NN4DCH/AA	56

• NC Curve

1) AM009NN4DCH/AA

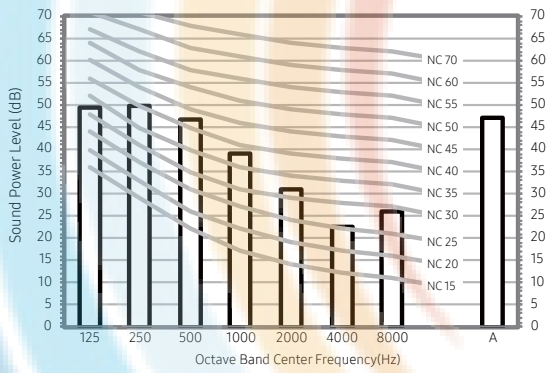

2) AM012NN4DCH/AA

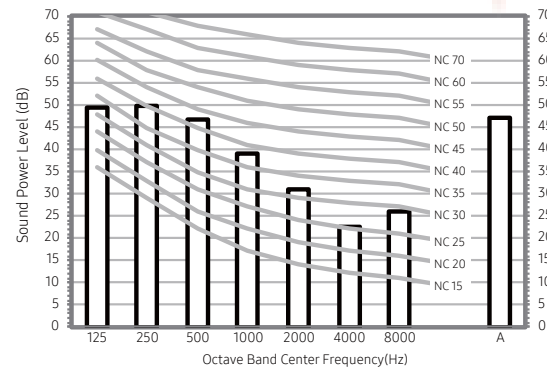

3) AM018NN4DCH/AA

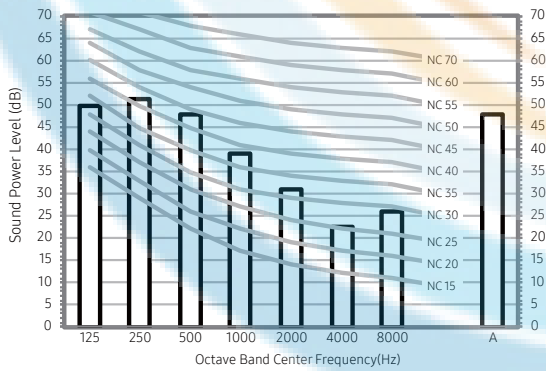

4) AM024NN4DCH/AA

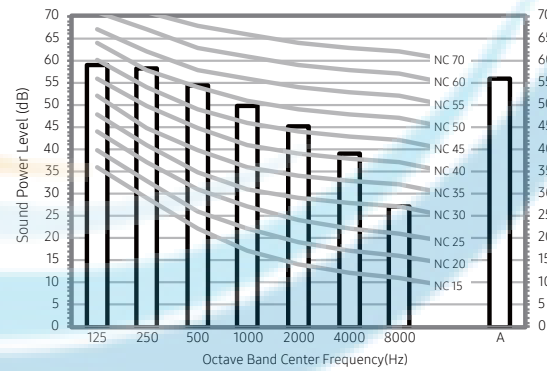

# 7. Sound Data

## Wind-Free 4Way Cassette

### Sound Power level

**NOTE**

Unit: dB(A)

- Specifications may be subject to change without prior notice
  - Sound power level is an absolute value that a sound source generates.
  - dBA = A-weighted sound power level.
  - Reference power : 1pW.
  - Measured according to ISO 3741.

Model	Power
AM030NN4DCH/AA	57
AM036NN4DCH/AA	58
AM048NN4DCH/AA	60

• NC Curve

5) AM030NN4DCH/AA

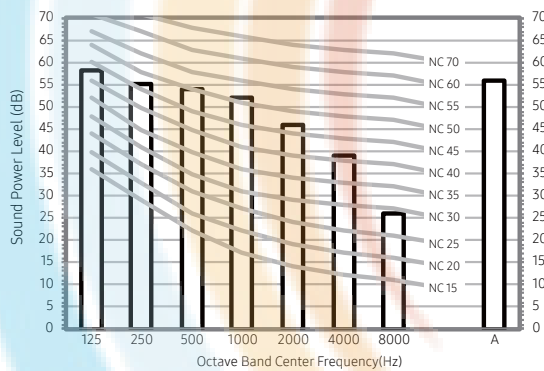

6) AM036NN4DCH/AA

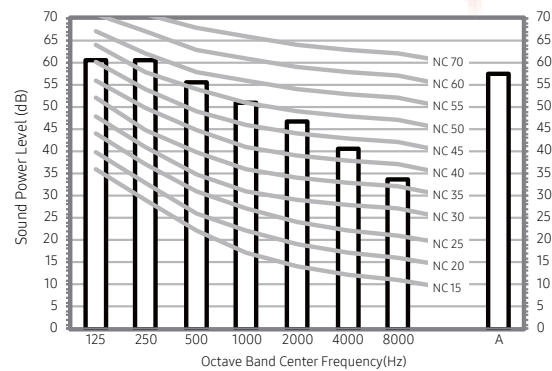

7) AM048NN4DCH/AA

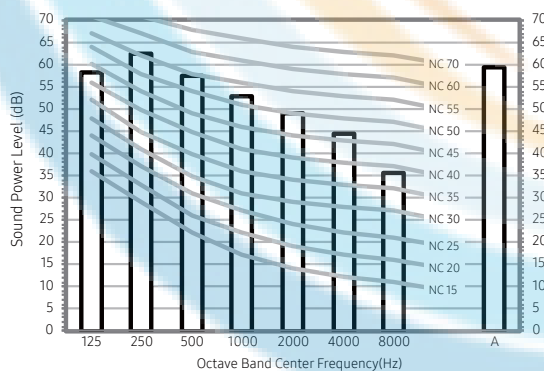

# 8. Temperature and air flow distribution

## Wind-Free 4Way Cassette

### AM009NN4DCH/AA

- Cooling Air Velocity distribution  
Discharge angle : 45°

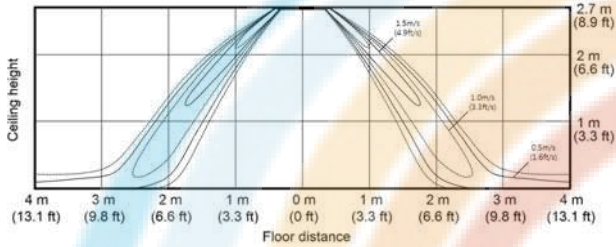

- Cooling Temperature distribution  
Discharge angle : 45°

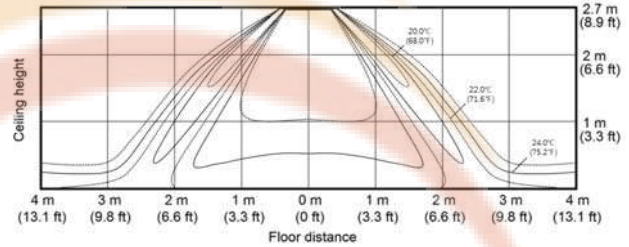

- Heating Air Velocity distribution  
Discharge angle : 52°

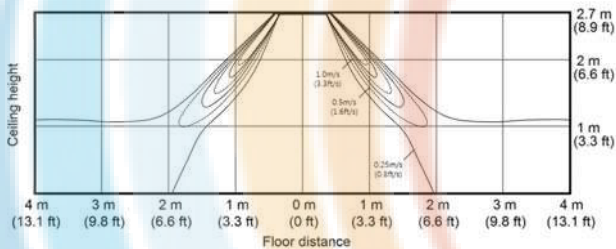

- Heating Temperature distribution  
Discharge angle : 52°

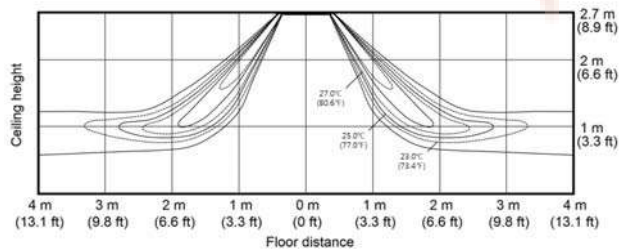

### AM012NN4DCH/AA

- Cooling Air Velocity distribution  
Discharge angle : 45°

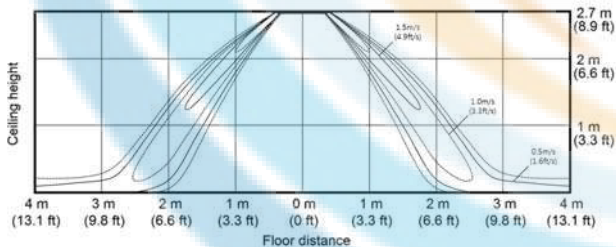

- Cooling Temperature distribution  
Discharge angle : 45°

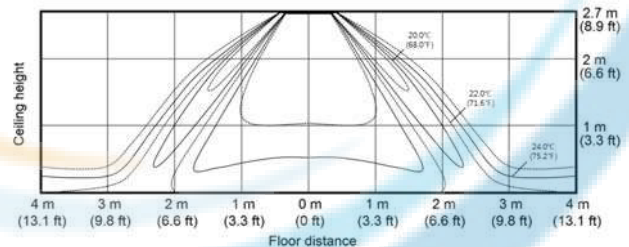

- Heating Air Velocity distribution  
Discharge angle : 52°

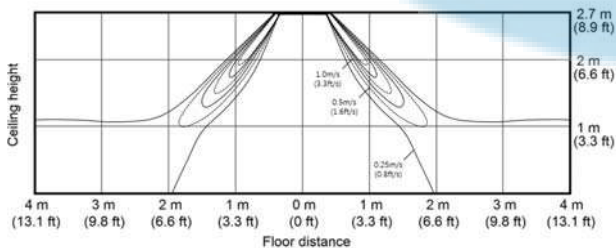

- Heating Temperature distribution  
Discharge angle : 52°

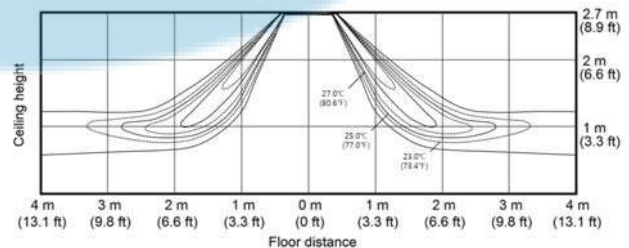

# 8. Temperature and air flow distribution

## Wind-Free 4Way Cassette

### AM018NN4DCH/AA

- Cooling Air Velocity distribution  
Discharge angle : 45°

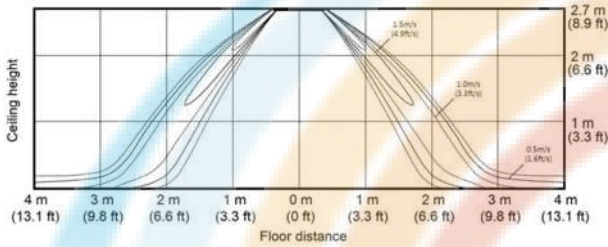

- Cooling Temperature distribution  
Discharge angle : 45°

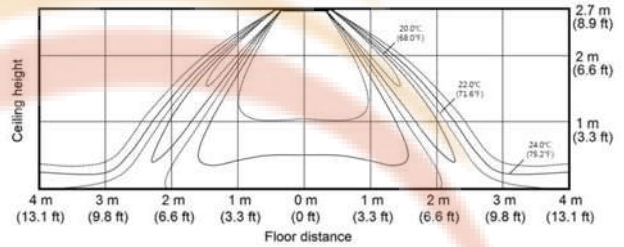

- Heating Air Velocity distribution  
Discharge angle : 52°

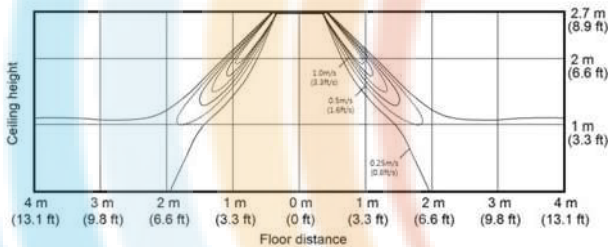

- Heating Temperature distribution  
Discharge angle : 52°

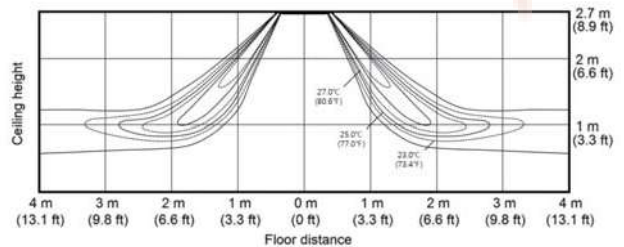

### AM024NN4DCH/AA

- Cooling Air Velocity distribution  
Discharge angle : 45°

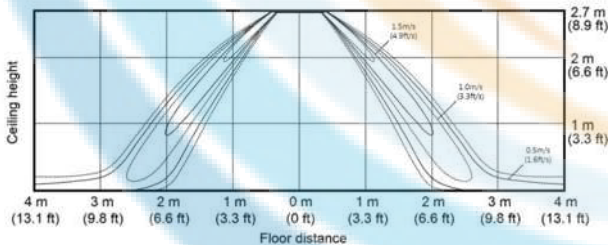

- Cooling Temperature distribution  
Discharge angle : 45°

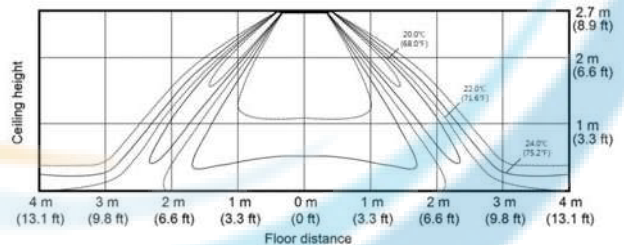

- Heating Air Velocity distribution  
Discharge angle : 52°

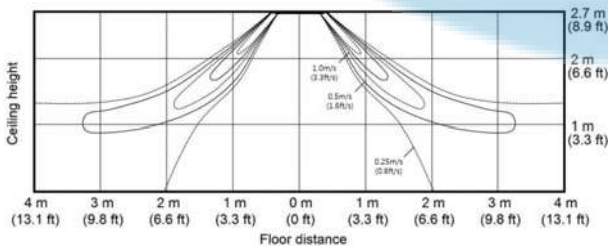

- Heating Temperature distribution  
Discharge angle : 52°

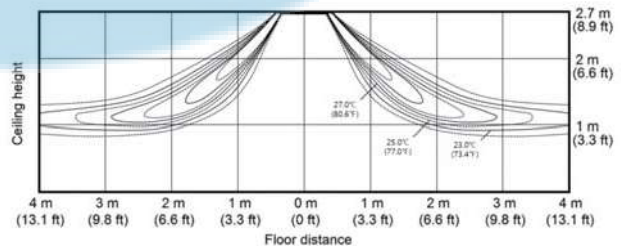



# 8. Temperature and air flow distribution

## Wind-Free 4Way Cassette

### AM030NN4DCH/AA

- Cooling Air Velocity distribution  
Discharge angle : 45°

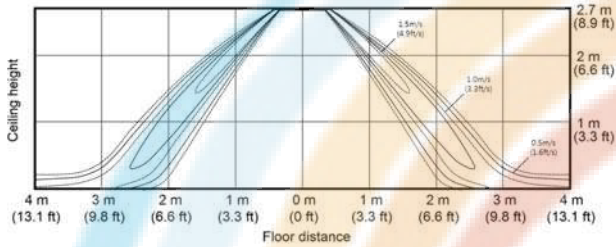

- Cooling Temperature distribution  
Discharge angle : 45°

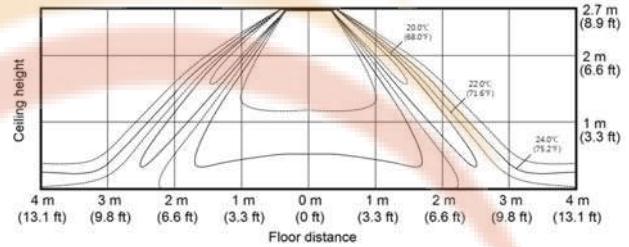

- Heating Air Velocity distribution  
Discharge angle : 52°

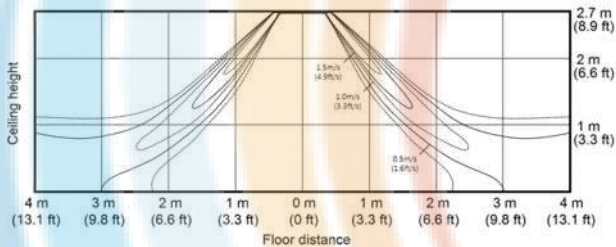

- Heating Temperature distribution  
Discharge angle : 52°

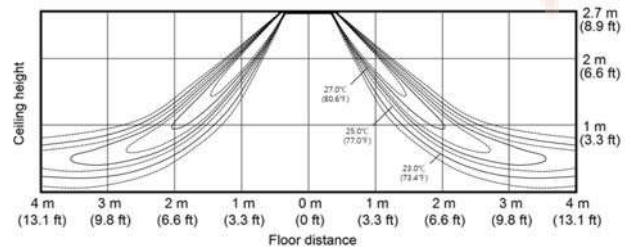

### AM036NN4DCH/AA

- Cooling Air Velocity distribution  
Discharge angle : 45°

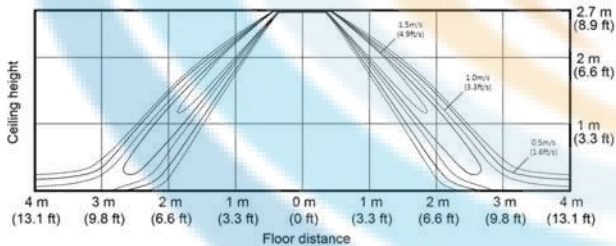

- Cooling Temperature distribution  
Discharge angle : 45°

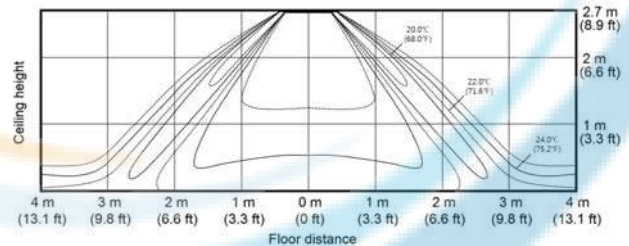

- Heating Air Velocity distribution  
Discharge angle : 52°

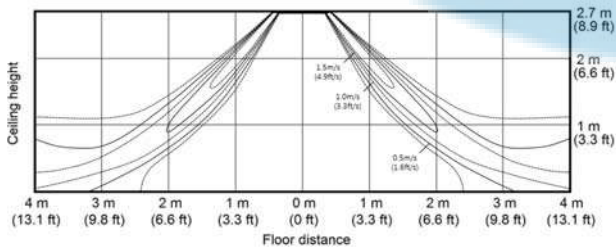

- Heating Temperature distribution  
Discharge angle : 52°

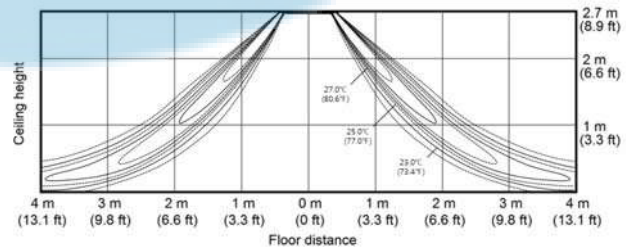

# 8. Temperature and air flow distribution

## Wind-Free 4Way Cassette

### AM048NN4DCH/AA

- Cooling Air Velocity distribution  
Discharge angle : 45°

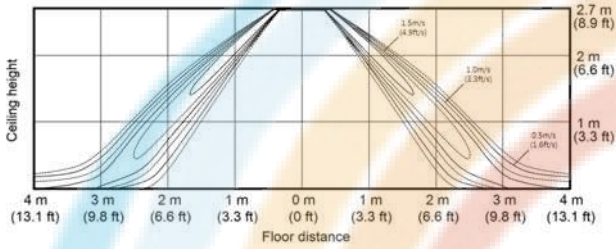

- Cooling Temperature distribution  
Discharge angle : 45°

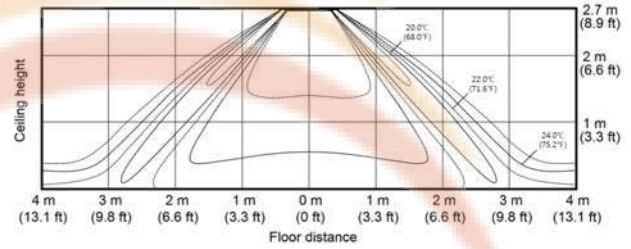

- Heating Air Velocity distribution  
Discharge angle : 52°

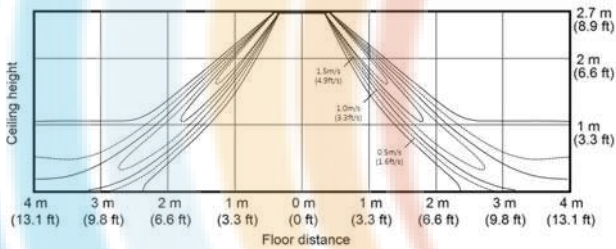

- Heating Temperature distribution  
Discharge angle : 52°

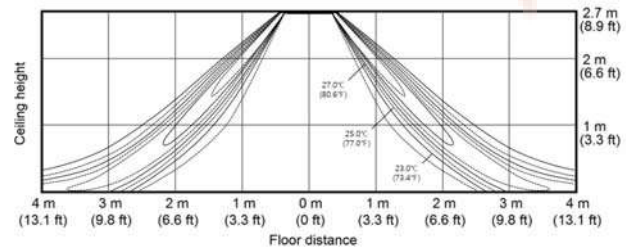



# 9. Piping Diagram

## Wind-Free 4Way Cassette

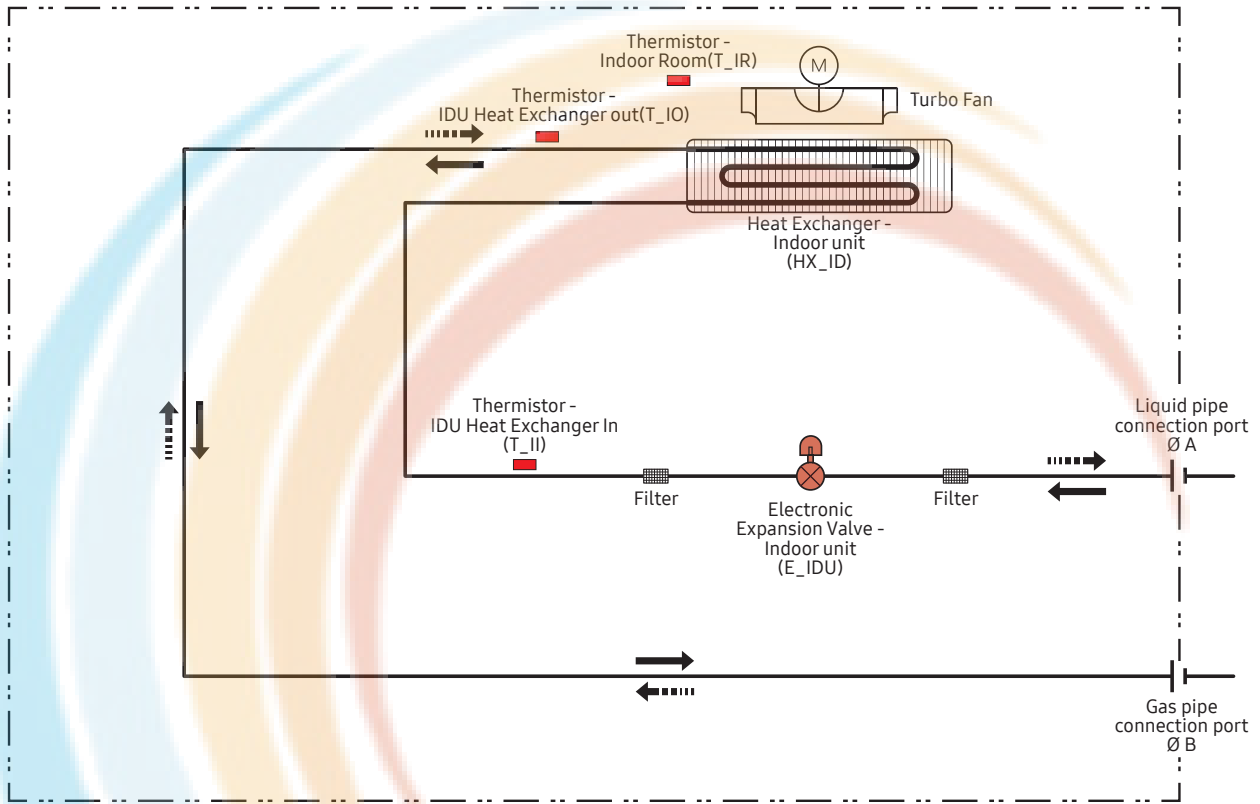

Refrigerant flow	
Cooling	Heating
→	⋯→

Unit : inches

Model	A	B
AM009NN4DCH/AA	1/4"	1/2"
AM012NN4DCH/AA		
AM018NN4DCH/AA		
AM024NN4DCH/AA	3/8"	5/8"
AM030NN4DCH/AA		
AM036NN4DCH/AA		
AM048NN4DCH/AA		

# Installation

## Step 1 Optional: Insulating the body of the indoor unit

If you install a cassette type indoor unit on the ceiling when temperature is over 27°C and humidity is over 80%, you must apply an extra 10 mm thick polyethylene insulation or a similar type of insulation to the body of the indoor unit.

Cut away the part where pipes are pulled out for the insulating work.

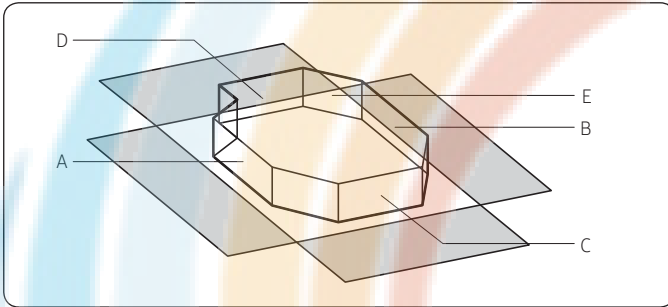

Insulate the end of the pipe and some curved area by using separate insulator.

## Step 2 Installing the indoor unit

Since the diagram is made of paper, it may shrink or stretch slightly due to temperature or humidity. For this reason, before drilling the holes, be sure to maintain the correct dimensions between the markings.

- 1 Insert bolt anchors, use existing ceiling supports or construct a suitable support as shown in figure.

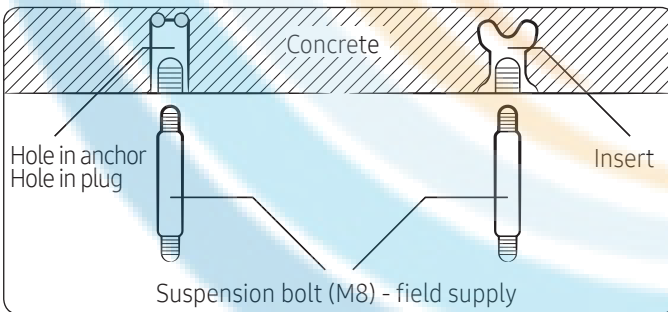

- 2 Install the suspension bolts, depending on the ceiling type.

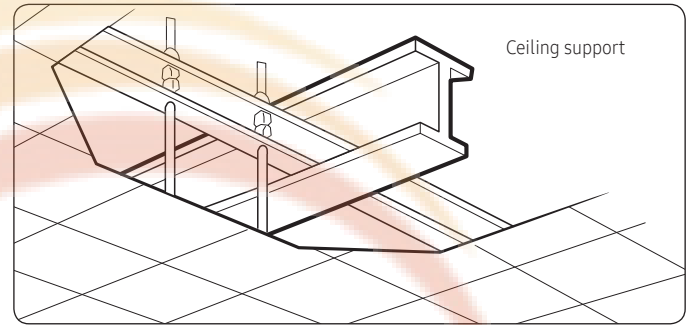

### ⚠ CAUTION

- Make sure that the ceiling is strong enough to support the weight of the indoor unit. Before hanging the unit, test the strength of each attached suspension bolt.
  - If the length of the suspension bolt is more than 1.5 m, you are required to prevent vibration.
- 3 Screw eight pairs of nuts and washers to the suspension bolts, making space for hanging the indoor unit.

### ⚠ CAUTION

- You must install all of the suspension rods.
- It is important to leave sufficient space in the false ceiling to allow access for maintenance or repairs to the drainage pipe connection, the refrigerant pipe connection, or to remove the unit if necessary.

# Installation

## Step 3 Insulating the refrigerant pipes

Once you have checked that there are no leaks in the system, you can insulate the piping and hose.

- 1 To avoid condensation problems, place Acrylonitrile Butadien Rubber separately around each refrigerant pipe.

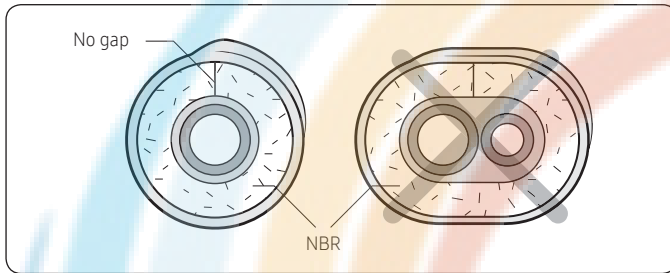

### NOTE

- Always make the seam of pipes face upwards.

### CAUTION

- The insulation has to be produced in full compliance with European regulation EEC / EU 2037 / 2000 requiring the use of sheaths insulation without using CFC and HCFC gases for health and the environment.
- 2 Wind insulating tape around the pipes and drain hose avoiding compressing the insulation too much.

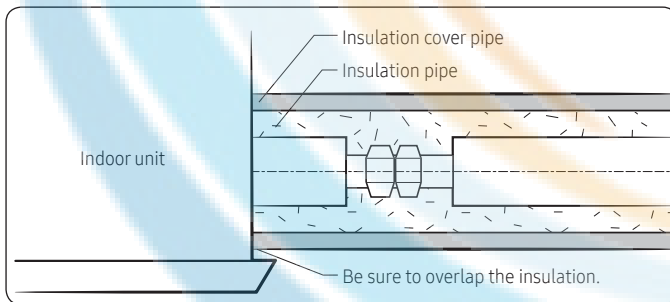

### CAUTION

- Be sure to wrap insulation tightly without any gaps.
- 3 Finish wrapping insulating tape around the rest of the pipes leading to the outdoor unit.
  - 4 The pipes and electrical cables connecting the indoor unit with the outdoor unit must be fixed to the wall with suitable ducts.

### CAUTION

- Must fit tightly against body without any gap.
- Make sure that all refrigerant connection must be accessible for easy maintenance and detachment.
- Install the insulation not to get wider and use the adhesives on the connection part of it to prevent moisture from entering.
- Wind the refrigerant pipe with insulation tape if it is exposed to outside sunlight.
- Install the refrigerant pipe respecting that the insulation does not get thinner on the bent part or hanger of pipe.
- Add the additional insulation if the insulation plate gets thinner.

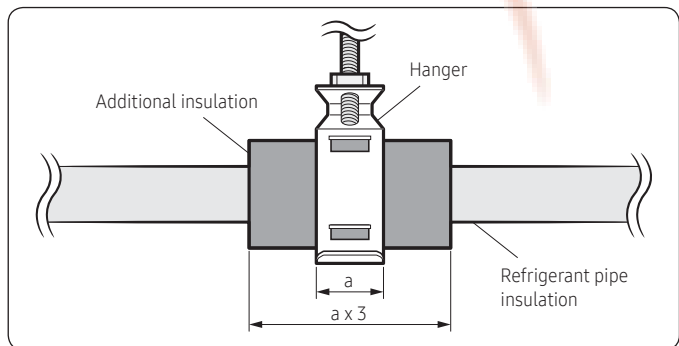

- 5 Select the insulation of the refrigerant pipe.
  - Insulate the gas side and liquid side pipe, noting the insulation thickness that must differ according to the pipe size.
  - Standard: Less than an indoor temperature of 30°C, with humidity at 85%. If installing in a high humidity environment, use one grade thicker insulator by referring to the table below. If installing in an unfavourable environment, use thicker one.
  - The heat-resistance temperature of the insulator must be more than 120°C.

# Installation

Pipe	Pipe size (mm)	Insulation Type (Heating/Cooling)		Remarks
		Standard [30°C, 85%]	High humidity [30°C, over 85%]	
		EPDM, NBR		
Liquid pipe	Ø6.35 to Ø9.52	9t	←	Internal temperature is higher than 120°C
	Ø12.7 to Ø50.80	13t	←	
Gas pipe	Ø6.35	13t	19t	
	Ø9.52 to Ø25.40	19t	25t	
	Ø28.58 to Ø44.45		32t	
	Ø50.80	25t	38t	

- When installing insulation in the places and conditions below, use the same insulation that is used for high humidity conditions.

<b>&lt;Geological condition&gt;</b>
High humidity locations such as shorelines, hot springs, lake or riversides, and ridges (when part of the building is covered by earth and sand)
<b>&lt;Operation purpose condition&gt;</b>
Restaurant ceiling, sauna, swimming pool etc.
<b>&lt;Building construction condition&gt;</b>
Ceilings frequently exposed to moisture and cooling are not covered. For example, pipes installed at a corridor of a dormitory and studio or near an exit that opens and closes frequently.
Places (where the pipes are installed) that are highly humid due to a lack of ventilation.

- Refrigerant pipe before EEV kit and MCU or without EEV kit and MCU
  - You can contact the gas side and liquid side pipes but the pipes should not be pressed.
  - When contacting the gas side and liquid side pipe, use 1 grade thicker insulator.
- Refrigerant pipe after EEV kit and MCU
  - Install the gas side and liquid side pipes, leave 10mm of space.
  - When contacting the gas side and liquid side pipe, use 1 grade thicker insulator.

## Step 4 Installing the drain hose and drain pipe

- Push the supplied drain hose as far as possible over the drain socket.
- Tighten the metal clamp as shown in the picture.

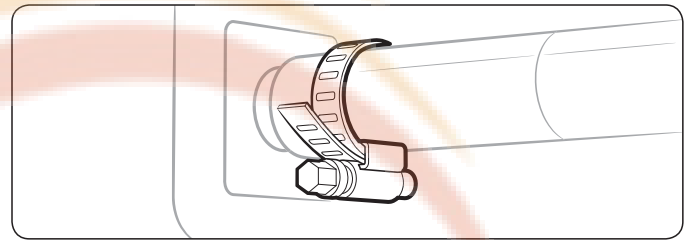

- Wrap the supplied large sealing pad over the metal clamp and drain hose to insulate and fix it with clamps.
- Insulate the complete drain piping inside the building (field supply). If the drain hose cannot be sufficiently set on a slope, fit the hose with drain raising piping (field supply).
- Push the drain hose up to insulation when connecting the drain hose to drain socket.

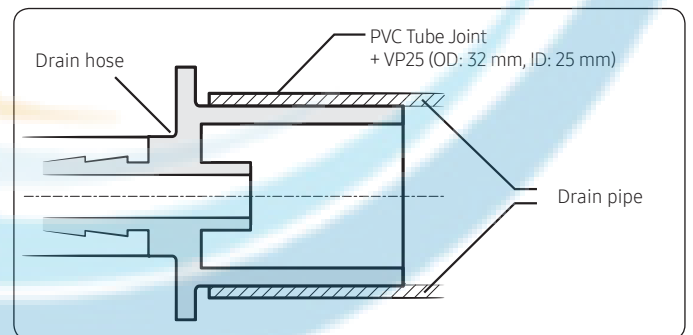
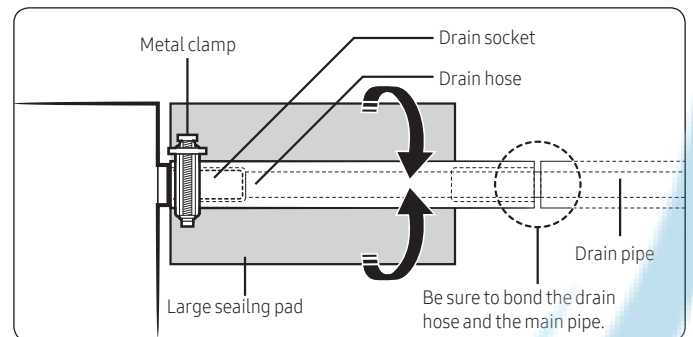

### ⚠ CAUTION

Check that the indoor unit is level with the ceiling by using the leveller.

# Installation

- Install air ventilation to drain condensation smoothly.

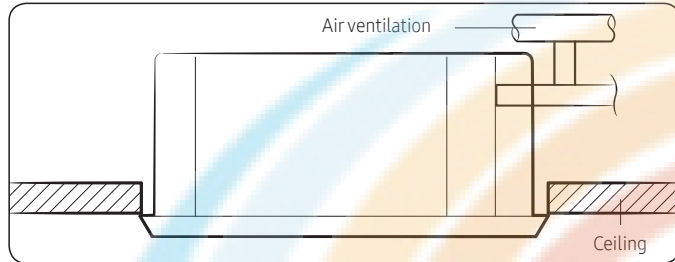

- If it is necessary to increase the height of the drain pipe, install the drain pipe straight within 300 mm from the drain hose port. If it is raised higher than 550 mm, there may be water leaks.

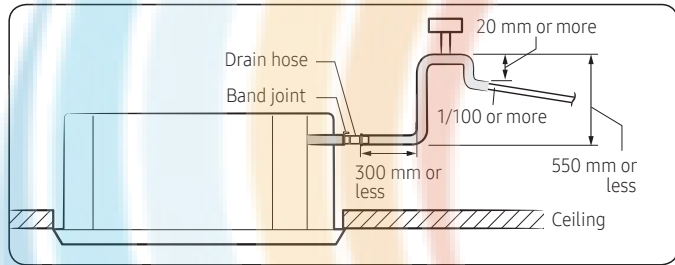

- Do not give the hose an upward gradient beyond the connection port. This will cause water to flow backwards when the unit is stopped, resulting in water leaks.

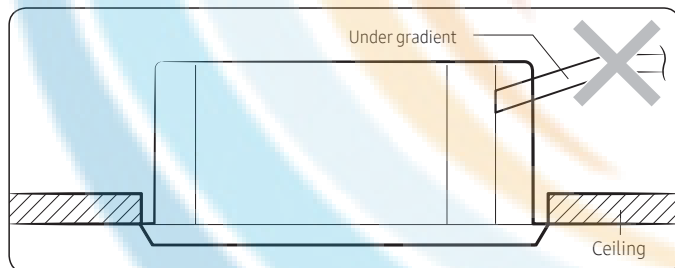

- Do not apply force to the piping on the unit side when connecting the drain hose. The hose should not be allowed to hang loose from its connection to the unit. Fasten the hose to a wall, frame or other support as close to the unit as possible.

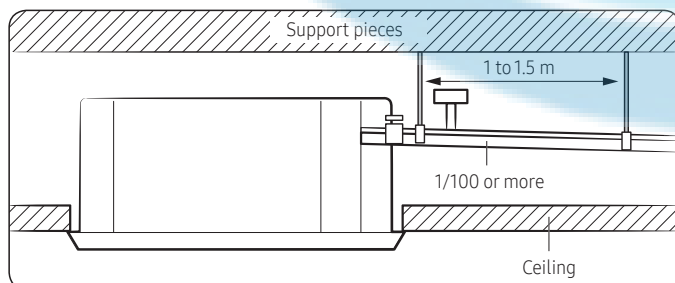

- Install horizontally.

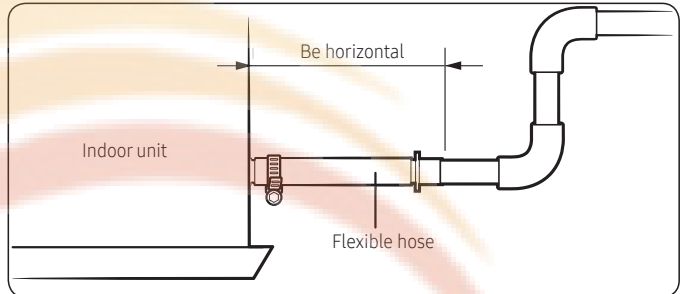

- Max. allowable axis gap.

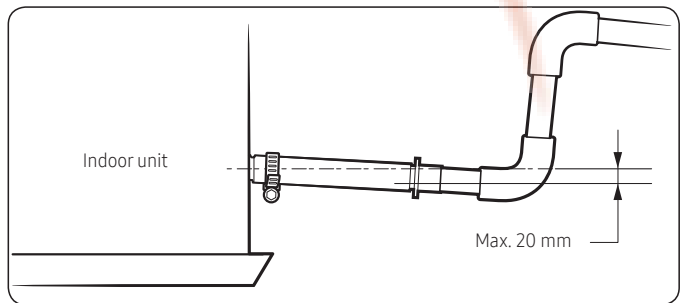

- Max. allowable bending angle.

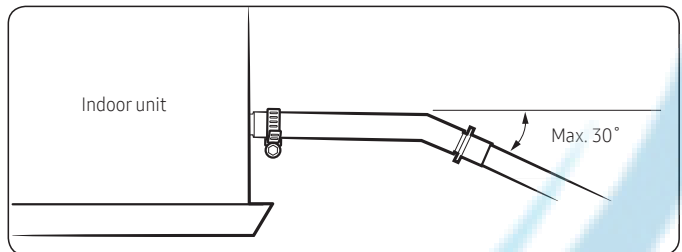

## NOTE

- If a concentrated drain pipe is installed, refer to the figure below.

# Installation

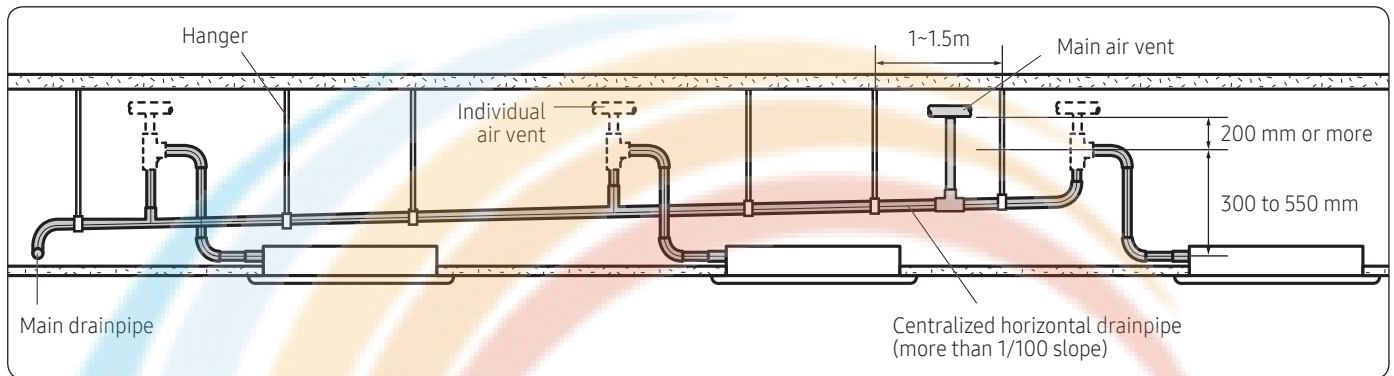

- If 3 or more units are installed, install the main air vent at the front of the farthest indoor unit from the main drain pipe.
- To prevent water from flowing back to indoor units, install an individual air vent at the top of each indoor unit.
  - The air vents should be T or 7 shaped to prevent dust or foreign substances from entering.
  - You may not need to install air vent if the horizontal drain pipe is in proper slope.

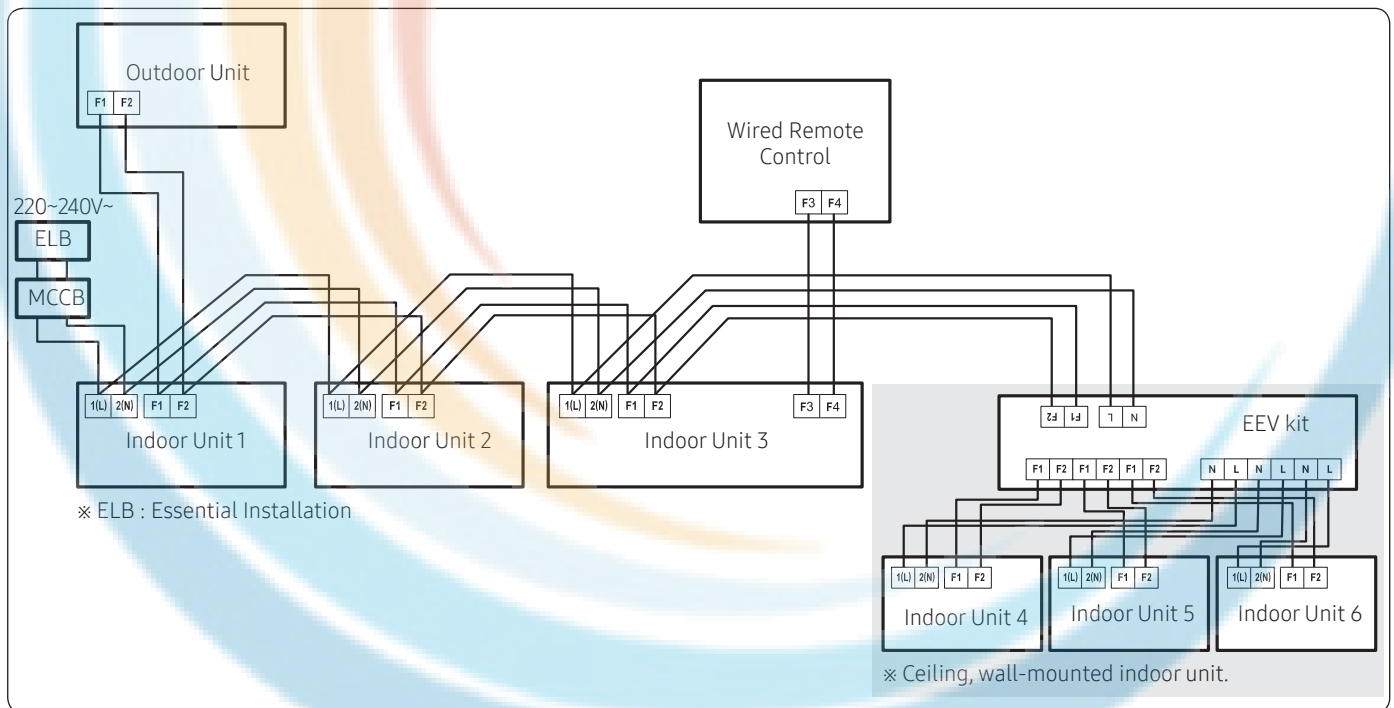



# Installation

## Specifications of the terminal blocks

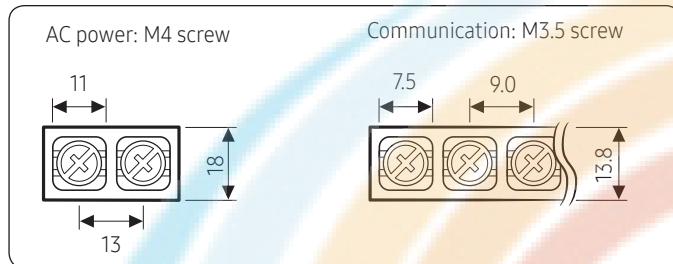

Power supply (single phase)	MCCB	ELB
Min : 198V Max : 242V	XA	XA, 30 mA 0.1 s
Power cable	Earth cable	Communication cable
2.5 mm <sup>2</sup> or more	2.5 mm <sup>2</sup>	0.75 to 1.5 mm <sup>2</sup>

Decide the power cable specification and maximum length by formula 2.

1 Decide the capacity of ELB and MCCB by below formula.

$$\text{The capacity of ELB, MCCB } X[A] = 1.25 \times 1.1 \times \sum A_i$$

### NOTE

- X : The capacity of ELB, MCCB
- $\sum A_i$  : Sum of rating currents of each indoor unit.

## Rated currents

Model	Rating current(A)
AM045NN4DEH*	0.22
AM056NN4DEH*	0.22
AM071NN4DEH*	0.31
AM090NN4DEH*	0.43
AM112NN4DEH*	0.55
AM128NN4DEH*	0.51
AM140NN4DEH*	0.62

2 Decide the power cable specification and maximum length within 10% voltage drop among indoor units.

$$\sum_{k=1}^n \left( \frac{\text{Coef} \times 35.6 \times L_k}{1000 \times A_k} \times i_k \right) < 10\% \text{ of input voltage[V]}$$

### NOTE

- Coef: 1.55
- Lk: Distance among each indoor unit[m], Ak: Power cable specification[mm<sup>2</sup>]
- ik: Running current of each unit[A]

# Installation

## Example of Installation

Total power cable length L = 100(m), Initial pull-in current = 10[A], Running current of each units = 1[A], Total 10 indoor units were installed

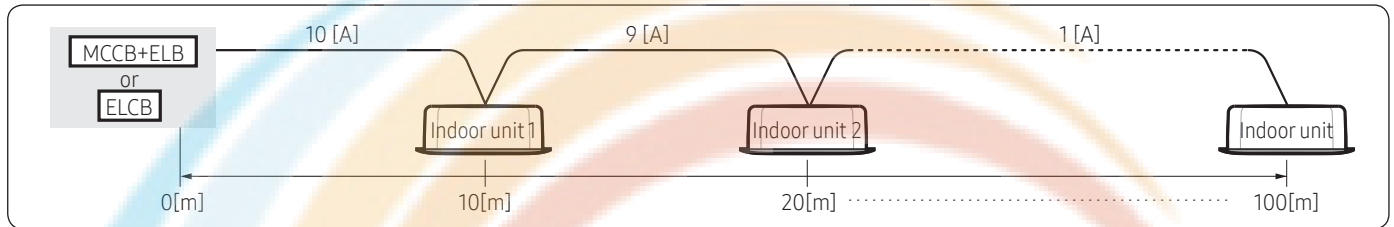

- Apply following equation.

$$\sum \left( \frac{\text{Coef} \times 35.6 \times L \times k \times j \times k}{k=1000 \times A \times k} \right) < 10\% \text{ of input voltage[V]}$$

- Calculation

- Installing with 1 sort wire.

$$\begin{array}{c} \begin{array}{c} | 2.5 \text{ [mm}^2\text{]} | 2.5 \text{ [mm}^2\text{]} | \dots\dots 2.5 \text{ [mm}^2\text{]} \dots\dots \\ | -2.2 \text{ [V]} | -2.0 \text{ [V]} | \dots\dots \end{array} \rightarrow \text{Within 198V to 242V} \\ 220 \text{ [V]} \qquad \qquad \qquad 208.8 \text{ [V]:} \\ \qquad \qquad \qquad \text{Applicable} \\ -(2.2+2.0+1.8+1.5+1.3+1.1+0.9+0.7+0.4+0.2)=-11.2 \text{ [V]} \end{array}$$

- Installing with 2 different sort wire.













$$\begin{array}{c} \begin{array}{c} | 4.0 \text{ [mm}^2\text{]} | 4.0 \text{ [mm}^2\text{]} | \dots\dots 2.5 \text{ [mm}^2\text{]} \dots\dots \\ | -1.4 \text{ [V]} | -1.2 \text{ [V]} | \dots\dots \end{array} \rightarrow \text{Within 198V to 242V} \\ 220 \text{ [V]} \qquad \qquad \qquad 209.5 \text{ [V]:} \\ \qquad \qquad \qquad \text{Applicable} \\ -(1.4+1.2+1.8+1.5+1.3+1.1+0.9+0.7+0.4+0.2)=-10.5 \text{ [V]} \end{array}$$

## CAUTION

- Select the power cable in accordance with relevant local and national.
- Wire size must comply with local and national code.
- You should connect the power cable into the power cable terminal and fasten it with a clamp.
- The unbalanced power must be maintained within 10% of supply rating among whole indoor units.
- If the power is unbalanced greatly, it may shorten the life of the condenser. If the unbalanced power is exceeded over 10% of supply rating, the indoor unit is protected, stopped and the error mode indicates
- Connect the power cable to the auxiliary circuit breaker. An all pole disconnection from the power supply must be incorporated in the fixed wiring ( $\geq 3\text{mm}$ ).







# Accessory

## Controller

Classification	Product	Image	Model	Remark
Intergrated Management System	DMS 2.0		MIM-D00AUN	
	DMS 2.5		MIM-D01AUN	
	S-NET 3		MST-P3P	
Buiding Management System	BACnet G/W		MIM-B17N, MIM-B17UN	
			MIM-B17BN, MIM-B17BUN	
	LONWORKS G/W		MIM-B18N, MIM-B18UN	
			MIM-B18BN, MIM-B18BUN	
Centralized Control System	On/Off Controller		MCM-A202DN	
	Touch Controller		MCM-A300N	
	Wi-Fi Kit		MIM-H03N, MIM-H03UN	
Individual Control System	Wireless remote Controller		AR-EH03E	Except for 360 Cassette
			AR-KH00U	360 Cassette Only
	Wired remote Controller		MWR-WE13N	
			MWR-SH00N	Simple Type
			MWR-SH10N	Touch Simple Type

# Accessory

## Controller

Classification	Product	Image	Model	Remark
Zone Control System	External room sensor		MRW-TS	
Others	External room sensor		MRW-TA	
	Compatible interface module		MIM-N01	
	External contact interface module		MIM-B14	
	Modbus Interface Module		MIM-B19N	
	S-Converter		MIM-C02N	
	Wireless signal receiver		MRK-A10N	Duct type only

- In case you want more information about the accessories, please refer to the control and accessories TDB on [pvi.samsung.com](http://pvi.samsung.com) site.

# Accessory

## Indoor Unit's Accessory

Product	Image	Model	Remark
Panel		PC4SUSMFN	4 Way Cassette(600 x 600) (Classic)
		PC4SUFMAN PC4SUFMUN	Wind-Free 4 Way Cassette(600 x 600)
		PC4NUSKAN	4 Way Cassette (Waffle)
		PC4NUSKFN	4 Way Cassette (Classic)
		PC4NUFMAN PC4NUFMUN	Wind-Free 4 Way Cassette
S-Plasma Ion KIT		MSD-CAN1	[Option] 4Way, 4Way(600x600), 360, Ceiling [Included] Console
		MSD-EAN1	[Option] Duct S, Big Duct, ERV, ERV Plus
Motion detect Sensor		MCR-SMC	Wind-Free 4Way Cassette
		MCR-SMD	Wind-Free 4Way Cassette (600x600)
		MCR-SMA	4Way Cassette (600x600)
Drain Pump		MDP-E075SEE3D	Slim Duct
		MDP-G075SP	Duct S (External)
		MDP-G075SQ	Duct S (Internal)
Joint		MXJ-2D2509K	2 indoor units connection
		MXJ-3D2509K	3 indoor units connection
		MXJ-4D2509K	4 indoor units connection

- In case you want more information about the accessories, please refer to the control and accessories TDB on pvi.samsung.com site.



2019. 01  
Ver.1.1

**Samsung Electronics Co., LTD.**  
**B2B PM / SE**

Head Office (Suwon Korea) 129, Samsung-Ro, Yeongtong-Gu, Suwon City, Gyeonggi-Do, Korea 16677  
Website : [www.samsung.com](http://www.samsung.com), <http://btsp.samsungsbn.com> Email : [airconditioner@samsung.com](mailto:airconditioner@samsung.com)  
Images and data in this book may subject to change without prior notice.